





# Dell™ Inspiron™ 4150

[A Tour of Your Computer](#)  
[Solving Problems](#)  
[Reinstalling Drivers and Utilities](#)  
[Reinstalling the Microsoft® Windows® XP Operating System](#)  
[Using the System Setup Program](#)  
[Power Management](#)  
[Using the Dell Diagnostics](#)  
[Specifications](#)  
[Pin Assignments for I/O Connectors](#)  
[Removing and Replacing Parts](#)

---

 **CAUTION:** Follow the safety instructions in the *Owners Manual* to help protect your computer from damage and ensure your own personal safety.

## Hints, Notices, and Cautions

-  **HINT:** A HINT indicates important information that helps you make better use of your computer.
-  **NOTICE:** A NOTICE indicates either potential damage to hardware or loss of data and tells you how to avoid the problem.
-  **CAUTION:** A CAUTION indicates a potential for property damage, personal injury, or death.

## Abbreviations and Acronyms

For a complete list of abbreviations and acronyms, see the *Tell Me How* help file (see "[Accessing Help](#)").

---

Information in this document is subject to change without notice.  
© 2002 Dell Computer Corporation. All rights reserved.

Reproduction in any manner whatsoever without the written permission of Dell Computer Corporation is strictly forbidden.

Trademarks used in this text: *Dell*, the *DELL* logo, *Inspiron*, *Dell TravelLite*, and *AccessDirect* are trademarks of Dell Computer Corporation; *Intel* and *Pentium* are registered trademarks of Intel Corporation; *Microsoft*, *Windows*, and *MS-DOS* are registered trademarks of Microsoft Corporation.

Other trademarks and trade names may be used in this document to refer to either the entities claiming the marks and names or their products. Dell Computer Corporation disclaims any proprietary interest in trademarks and trade names other than its own.

Model PP01L

November 2002 Rev. A01

## Battery and Module Bay Latches

Dell™ Inspiron™ 4150

### Removing the Battery and Module Bay Latches

- ➔ **NOTICE:** Disconnect the computer and any attached devices from electrical outlets, and remove any installed batteries.
- ➔ **NOTICE:** To avoid ESD, ground yourself by using a wrist grounding strap or by touching an unpainted metal surface on the computer.
- ➔ **NOTICE:** Read "[Preparing to Work Inside the Computer](#)" before performing the following procedure.

1. Remove the [hard drive](#).
2. Remove the [keyboard](#).
3. Remove the [display](#).
4. Remove the [palm rest](#).
5. Remove the [system board](#).
6. Remove the latch button by using a plastic scribe to push on the snap tabs until the latch button is released from the bottom case.

To prevent the latch assembly from coming loose, apply pressure to the latch and spring while removing the latch button.

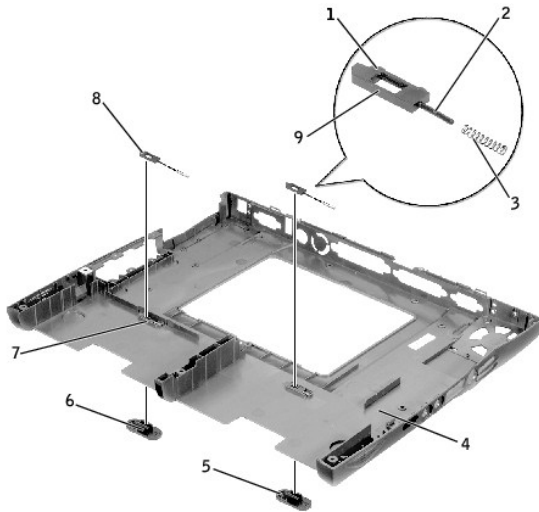

1	bumps (2 per latch)	6	snap tabs (2 per latch button)
2	slider	7	holding feature (2)
3	spring	8	upper latch assembly (2)
4	bottom case	9	wear rib
5	latch buttons (2)		

### Replacing the Battery and Module Bay Latches

1. If you are replacing the upper latch assembly:
  - a. Slide the spring onto the slider, and reinstall the latch in the holding features on the inside of the bottom case.
  - b. Ensure that the slider is inserted into the hole, that the side of the latch with the two bumps is facing the back of the case, and that the side with the wear rib is facing the front of the case.

🔍 **HINT:** The latch will not function properly if the slider is oriented incorrectly.

2. Snap in the new latch button from behind the bottom case, making certain that the snap tabs are fully engaged in the latch.

To prevent the latch assembly from coming loose, apply pressure to the latch and spring while installing the latch button.

3. Ensure that the newly installed latch moves smoothly and freely when pushed and released.

---

[Back to Contents Page](#)

## Before You Remove or Replace Parts

Dell™ Inspiron™ 4150

- [Preparing to Work Inside the Computer](#)
  - [Recommended Tools](#)
  - [Screw Identification](#)
- 

### Preparing to Work Inside the Computer

 **CAUTION:** Only a certified service technician should perform repairs on your computer. Damage due to servicing that is not authorized by Dell is not covered by your warranty. Read and follow applicable safety instructions in the *Owner's Manual* that came with the computer.

 **NOTICE:** To avoid damaging the computer, perform the following steps before you begin working inside the computer.

1. Ensure that the work surface is clean to prevent scratching the computer cover.
2. Save any work in progress and exit all open programs.
3. Turn off the computer and all attached devices.

 **HINT:** Ensure that the computer is turned off and not in suspend mode or hibernate mode. If you cannot shut down the computer using the computer operating system, press and hold the power button for 4 seconds.

4. Ensure that the computer is undocked.
5. Disconnect the computer from the electrical outlet.
6. To avoid possible damage to the system board, wait 10 to 20 seconds and then disconnect any attached devices.
7. Disconnect all other external cables from the computer.
8. Remove any installed PC Cards or plastic blanks from the PC Card slot.
9. Close the display and turn the computer upside down on a flat work surface.

 **NOTICE:** To avoid damaging the system board, you must remove the main battery and secondary battery (if present) before you service the computer.

10. Remove the primary battery from the battery bay and the secondary battery from the module bay, if a secondary battery is in use.
  11. Remove any device installed in the module bay.
  12. To dissipate any static electricity while you work, use a wrist grounding strap or periodically touch an unpainted metal surface.
  13. Handle components and cards with care. Do not touch the components or contacts on a card. Hold a card by its edges or by its metal mounting bracket. Hold a component such as a microprocessor by its edges, not by its pins.
- 

### Recommended Tools

The procedures in this manual require the following tools:

- 1 #1 magnetized Phillips screwdriver
- 1 ¼-inch flat-blade screwdriver
- 1 Small plastic scribe
- 1 Microprocessor extractor
- 1 Flash BIOS update program CD







1	back
2	right
3	front
4	left

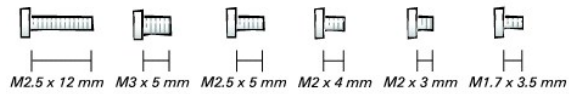





















## Screw Identification

When you are removing and replacing components, photocopy the place mat as a tool to lay out and keep track of the screws. The place mat provides the number of screws and their sizes.



**NOTICE:** When reinstalling a screw, you must use a screw of the correct diameter and length. Make sure that the screw is properly aligned with its corresponding hole, and avoid over tightening.

<p>Hard Drive Door: (1 each)</p>  <p><i>M3 x 5 mm</i></p>	<p>Keyboard to Bottom Case: (5 each)</p>  <p><i>M2.5 x 12 mm</i></p>
<p>Display Bezel: (6 each)</p>  <p><i>M2.5 x 5 mm</i></p> <p>Rubber Screw Covers (6 each)</p>	<p>Hinge Bracket to Bottom Case: (5 each)</p>  <p><i>M2.5 x 5 mm</i></p>
<p>Display Assembly to Top Cover: (5 each)</p>	<p>Display-Feed Flex Cable: (4 each)</p>

  <b>M2 x 4 mm</b>	  <b>M2 x 3 mm</b>
<p>Palm Rest to Bottom Case: (5 each) (3 each)</p>     <b>M2 x 3 mm</b> <b>M2.5 x 12 mm</b>	<p>Hybrid Cooling Fan: (2 each) (1 each)</p>     <b>M2.5 x 5 mm</b> <b>M2 x 3 mm</b>
<p>System Board to Bottom Case: (10 each)</p>   <b>M2.5 x 5 mm</b>	<p>Modem to System Board: (2 each)</p>   <b>M2 x 3 mm</b>
<p>Display Latch: (2 each) (2 each)</p>     <b>M2.5 x 5 mm</b> <b>M1.7 x 3.5 mm</b>	<p>Memory Module Cover: (2 captive screws) (1 each)</p> <p>The single screw is one of the five keyboard screws.</p>   <b>M2.5 x 12 mm</b>

# Microprocessor

Dell™ Inspiron™ 4150

- [Microprocessor Module](#)
- [Flashing the BIOS](#)

## Microprocessor Module

### Removing the Microprocessor Module

- ➔ **NOTICE:** Disconnect the computer and any attached devices from electrical outlets, and remove any installed batteries.
- ➔ **NOTICE:** To avoid ESD, ground yourself by using a wrist grounding strap or by touching an unpainted metal surface on the computer.
- ➔ **NOTICE:** Read "[Preparing to Work Inside the Computer](#)" before performing the following procedure.
- ➔ **NOTICE:** When replacing the microprocessor, to ensure proper thermal operation, always install a new thermal cooling assembly that is compatible with the new microprocessor.
- ➔ **NOTICE:** Do not touch the processor die. Press and hold the microprocessor down on the substrate on which the die is mounted while turning the cam screw to prevent intermittent contact between the cam screw and microprocessor.
- ➔ **NOTICE:** To avoid damage to the microprocessor, hold the screwdriver so that it is perpendicular to the microprocessor when turning the cam screw.

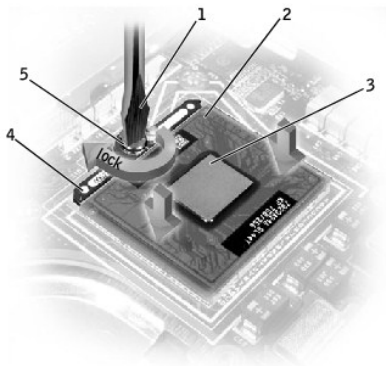

1	screwdriver (perpendicular to microprocessor)
2	pin-1 corner
3	processor die (do not touch)
4	ZIF socket
5	ZIF-socket cam screw

1. Remove the [hard drive](#).
2. Remove the [keyboard](#).

➔ **NOTICE:** To ensure maximum cooling for the microprocessor, do not touch the heat transfer areas on the microprocessor thermal cooling assembly. The oils in your skin reduce the heat transfer capability of the thermal pads.

3. Remove the [microprocessor thermal cooling assembly](#).

➔ **NOTICE:** When removing the microprocessor module, pull the module straight up. Be careful not to bend the pins on the microprocessor module.

4. To loosen the ZIF socket, use a small, flat-blade screwdriver and rotate the ZIF-socket cam screw counterclockwise until it comes to the cam stop.

The ZIF-socket cam screw secures the microprocessor to the system board. Take note of the arrow on the ZIF-socket cam screw.

5. Use a microprocessor extraction tool to remove the microprocessor module.

### Replacing the Microprocessor Module

- ➔ **NOTICE:** Ensure that the cam lock is in the fully open position before seating the microprocessor module. Seating the microprocessor module properly in the ZIF socket does not require force.
- ➔ **NOTICE:** A microprocessor module that is not properly seated can result in an intermittent connection or permanent damage to the microprocessor and ZIF socket.

1. Align the pin-1 corner of the microprocessor module with the pin-1 corner of the ZIF socket, and insert the microprocessor module.

 **HINT:** The pin-1 corner of the microprocessor module has a triangle that aligns with the triangle on the pin-1 corner of the ZIF socket.

- ➔ **NOTICE:** You must position the microprocessor module correctly in the ZIF socket to avoid permanent damage to the module and the socket.

When the microprocessor module is correctly seated, all four corners are aligned at the same height. If one or more corners of the module are higher than the others, the module is not seated correctly.

- ➔ **NOTICE:** Hold the microprocessor down while turning the cam screw to prevent intermittent contact between the cam screw and microprocessor (see "[Removing the Microprocessor Module](#)").

2. Tighten the ZIF socket by turning the cam screw clockwise to secure the microprocessor module to the system board.

- ➔ **NOTICE:** When replacing the microprocessor, to ensure proper thermal operation, always install a new thermal cooling assembly that is compatible with the new microprocessor.

3. Install a new [microprocessor thermal cooling assembly](#).
4. [Update the BIOS](#) using a flash BIOS update program CD.

---

## Flashing the BIOS

To update the BIOS:

1. Ensure that the AC adapter is plugged into an electrical outlet and that the main battery is installed in the battery bay.
2. Turn on the computer, and when the Dell™ logo appears, press  immediately.

If you wait too long and the Windows® logo appears, continue to wait until you see the Windows desktop. Then shut down your computer and try again.

3. When the boot device list appears, highlight **CD/DVD/CD-RW drive** and press .
4. Insert the flash BIOS update CD, and reboot the computer.

The computer boots, updates the BIOS, and reboots.

5. Remove the flash BIOS update CD.

---

[Back to Contents Page](#)



[Back to Contents Page](#)

## Using the Dell Diagnostics

Dell™ Inspiron™ 4150

- [When to Use the Dell Diagnostics](#)
  - [Features of the Dell Diagnostics](#)
  - [Starting the Dell Diagnostics](#)
  - [Advanced Testing](#)
  - [Confirming the System Configuration Information](#)
- 

### When to Use the Dell Diagnostics

Whenever a major component or device in your computer does not function properly, you may have a component failure. If you are experiencing a problem with your computer, perform the checks in "[Solving Problems](#)" and run the Dell Diagnostics *before* you call Dell for technical assistance. Running the Dell Diagnostics may help you to resolve the problem yourself quickly without having to contact Dell for assistance.

If you are experienced with computers and know what component(s) you need to test, simply select the appropriate diagnostic test group(s) or subtest(s). If you are unsure about how to begin diagnosing a problem, see "[Starting the Dell Diagnostics](#)" and "[Advanced Testing](#)."

---

### Features of the Dell Diagnostics

The Dell Diagnostics helps you check your computer's hardware without any additional equipment and without destroying any data. By using the diagnostics, you can have confidence in your computer's operation. And if you find a problem you cannot solve by yourself, the diagnostic tests can provide you with important information you will need when talking to Dell's service and support personnel.

 **NOTICE:** Use the Dell Diagnostics to test only your Dell™ computer. Using this program with other computers may cause incorrect computer responses or result in error messages.

The diagnostic test groups or subtests also have these helpful features:

- 1 Options that let you perform quick checks or extensive tests on one or all devices
  - 1 An option that allows you to choose the number of times a test group or subtest is repeated
  - 1 The ability to display test results or to save them in a file
  - 1 Options to temporarily suspend testing if an error is detected, or to terminate testing when an adjustable error limit is reached
  - 1 Extensive online Help screens that describe the tests and how to run them
  - 1 Status messages that inform you whether test groups or subtests were completed successfully
  - 1 Error messages that appear if any problems are detected
- 

### Starting the Dell Diagnostics

The Dell Diagnostics are located on a hidden Diagnostic utility partition on your hard drive.

 **HINT:** If your computer cannot display a screen image, contact Dell. See your *Owner's Manual* for contact information.

1. Turn off the computer.
2. If the computer is connected to a docking device (docked), undock it. See the documentation that came with the docking device for instructions.
3. Connect the computer to an electrical outlet.
4. Press and hold down the [Dell AccessDirect™ button](#) while you turn on the computer.





 **HINT:** An alternate way of starting the Dell Diagnostics is to select **Diagnostics** from the [one-time boot menu](#).

The computer begins to run the Pre-boot System Assessment, a series of embedded diagnostics that perform initial testing on your system board, keyboard, hard drive, and display.

- 1 During the assessment, answer any questions that appear.
- 1 If a component failure is detected, the computer stops and beeps. To stop the assessment and reboot to the operating system, press  ; to continue to the next test, press  ; to retest the component that failed, press .
- 1 If failures are detected during the Pre-boot System Assessment, write down the error code(s) and then contact Dell before continuing on to the Dell Diagnostics. See your *Owner's Manual* for contact information.
- 1 If you receive a message stating that no Diagnostics utility partition has been found, follow the instructions on the screen to run the Dell

Diagnostics from your *Drivers and Utilities* CD.

If the Pre-boot System Assessment completes successfully, you receive the message **Booting Dell Diagnostic Utility Partition**. Press any key to continue.

- Press any key to start the Dell Diagnostics from the Diagnostics utility partition on your hard drive.
- After the Dell Diagnostics loads, the **Diagnostics Menu** appears. To select an option, highlight the option and press , or press the key that corresponds to the highlighted letter in the option you choose.
- When you have finished running the Dell Diagnostics, press  until you return to the **Diagnostics Menu**. To exit the Dell Diagnostics and reboot the computer, either type , or highlight **Exit** and press .

## Diagnostics Menu



Option	Function
Test All Devices	Performs extensive diagnostic tests or quick diagnostic tests on all devices.
Test One Device	Performs extensive diagnostic tests or quick diagnostic tests on one device after you select it from a list of device groups. After you select <b>Test One Device</b> , press  for more information about a test.
Advanced Testing	Allows you to modify the parameters of a test and select a group of tests to perform. You can access online Help for more information about <b>Advanced Testing</b> .
Information and Results	Provides test results, test errors, version numbers of the subtests used by the Dell Diagnostics, and additional help on the Dell Diagnostics.
Program Options	Allows you to change the settings of the Dell Diagnostics.
Exit	If the Dell Diagnostics are being run from the Diagnostics utility partition on the hard drive, reboots the computer. If the Dell Diagnostics are being run from a CD or floppy disk, exits to the MS-DOS® prompt.

For a quick check of your computer, select **Quick Tests** from the **Test All Devices** or **Test One Device** option. **Quick Tests** runs only the subtests that do not require user interaction and that do not take a long time to run. Dell recommends that you choose **Quick Tests** first to increase the odds of tracing the source of the problem quickly.

For a thorough check of your computer, select **Extended Tests** from the **Test All Devices** option.

To check a particular area of your computer, select **Extended Tests** from the **Test One Device** option, or select the **Advanced Testing** option to customize your test(s).





## Advanced Testing

When you select **Advanced Testing** from the **Diagnostics Menu**, the following screen appears, listing the diagnostic test groups and devices of the selected device group, and the screen allows you to select categories from a menu. Press the arrow keys or   to navigate the screen.

### Advanced Testing Main Screen



 **HINT:** The test groups reflect the configuration of your computer.

Information in the **Advanced Testing** screen is presented as follows:

- On the left side of the screen, the **Device Groups** area lists the diagnostic test groups in the order they will run if you select **All** from the **Run tests** menu category. Press  or  to highlight a test group.
- On the right side of the screen, the **Devices for Highlighted Group** area lists the computer's currently detected hardware and some of the relevant settings.
- Two lines at the bottom of the screen make up the menu area (see "[Advanced Testing Help Menu](#)"). The first line lists the categories you can select; press  or  to highlight a menu category. The second line gives information about the category currently highlighted.

### Advanced Testing Help Menu

For more information on using the **Advanced Testing** option:

- Press .
- Highlight the **Help** category and press , or press the key that corresponds to the highlighted letter in the category you choose.

### Advanced Testing Help Categories

Help Category	Description
---------------	-------------

Menu	Provides descriptions of the main menu screen area, the device groups, and the different diagnostic menus and commands and instructions on how to use them.
Keys	Explains the functions of the keystrokes that you can use in the Dell Diagnostics.
Device Group	Describes the test group that is presently highlighted in the <b>Device Groups</b> area on the main menu screen. It also provides reasoning for using some tests.
Device	Describes the function and purpose of the highlighted device in the <b>Device Groups</b> area. For example, the following information appears when you select the <b>Device Help</b> category for <b>Diskette</b> in the <b>Device Groups</b> area:  Diskette  Drive A  The diskette disk drive device reads and writes data to and from diskettes. Diskettes are flexible recording media, sometimes contained in hard shells. Diskette recording capacities are small and access times are slow relative to hard disk drives, but they provide a convenient means of storing and transferring data.
Test	Provides a thorough explanation of the test procedure of each highlighted test group subtest. An example of the <b>Diskette</b> subtest <b>floppy drive Seek Test</b> is as follows:  Diskette  Drive A - floppy drive Seek Test  This test verifies the drive's ability to position its read/write heads. The test operates in two passes: first, seeking from the beginning to ending cylinders inclusively, and second, seeking alternately from the beginning to ending cylinders with convergence towards the middle.
Versions	Lists the version numbers of the subtests that are used by the Dell Diagnostics.

---

## Confirming the System Configuration Information

When you boot your computer from your *Drivers and Utilities* CD, the diagnostics checks your system configuration information and displays it in the **Device Groups** area on the main screen.

The following sources supply this configuration information for the diagnostics:

- 1 The system configuration information settings (stored in NVRAM) that you selected while using the system setup program
- 1 Identification tests of the microprocessor, the video controller, the keyboard controller, and other key components
- 1 BIOS configuration information temporarily saved in RAM

Do not be concerned if the **Device Groups** area does not list the names of all the components or devices you know are part of your computer. For example, you may not see a printer listed, although you know one is attached to your computer. Instead, the printer is listed as a parallel port. The computer recognizes the parallel port as LPT1, which is an address that tells the computer where to send outgoing information and where to look for incoming information. Because your printer is a parallel communications device, the computer recognizes the printer by its LPT1 address and identifies it as a parallel port. You can test your printer connection in the **Parallel Ports** tests.

---

[Back to Contents Page](#)

## Display, Display Assembly, Display Latch, and Hinge Covers

### Dell™ Inspiron™ 4150

- [Display](#)
- [Display Assembly](#)
- [Display Latch](#)
- [Hinge Covers](#)

---

## Display

- ➔ **NOTICE:** You must remove the display before you remove the palm rest.
- ➔ **NOTICE:** Disconnect the computer and any attached devices from electrical outlets, and remove any installed batteries.
- ➔ **NOTICE:** To avoid ESD, ground yourself by using a wrist grounding strap or by touching an unpainted metal surface on the computer.
- ➔ **NOTICE:** Read "[Preparing to Work Inside the Computer](#)" before performing the following procedure.



1	M2 x 3-mm screws (4)
2	top cover
3	center control cover
4	M2.5 x 5-mm screws (5)
5	bottom case
6	EMI shield bracket

1. Remove the [hard drive](#).
  2. Remove the [center control cover](#).
  3. Remove the [keyboard](#).
  4. Close the display.
  5. From the back of the computer, remove the five M2.5 x 5-mm screws labeled "circle D."
  6. Open the display approximately 180 degrees and support the display so that it does not open past this position.
  7. Remove the two M2 x 3-mm screws on the EMI shield bracket, which is attached to the display-feed flex cable.
  8. Remove the two M2 x 3-mm screws that secure the display-feed flex cable to the system board.
- ➔ **NOTICE:** When reconnecting the display-feed flex cable connector to the system board, push down on the top-left and top-right ends of the connector. Pressing on the center of the connector may damage resistors and compromise EMI protection in the computer.

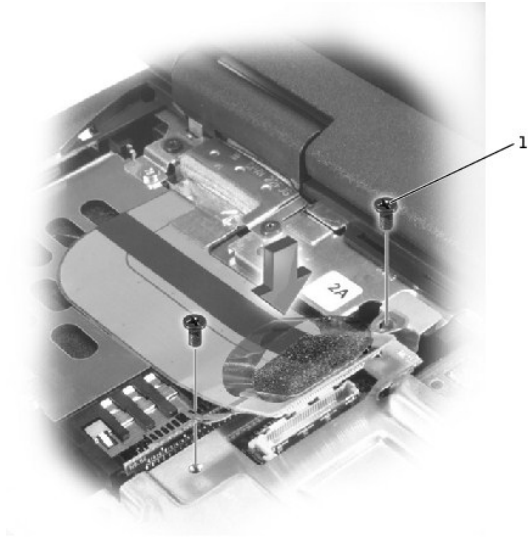

1	M2 x 3-mm screws (2)
---	----------------------

9. Pull up on the pull-tab that is attached to the display-feed flex cable connector to remove the tab from the interface connector on the system board.
10. Pivot the display up to a 90-degree angle, and lift it up and out of the bottom case.

## Display Assembly

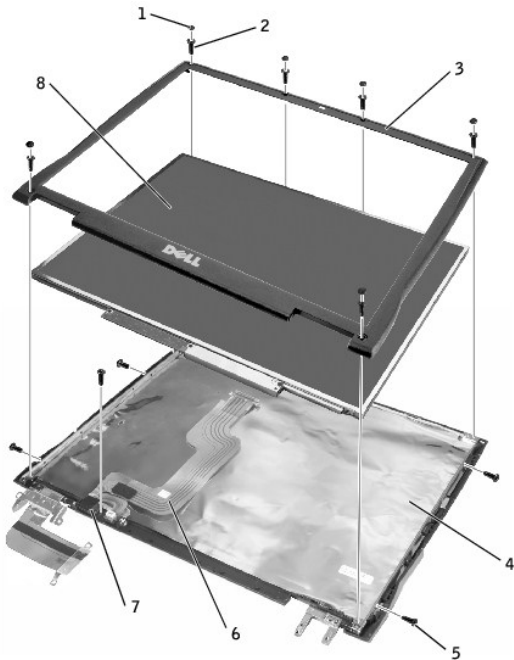

1	rubber screw covers (4)	5	M2 x 4-mm screws (5)
2	M2.5 x 5-mm screws (4)	6	display-feed flex cable
3	display bezel	7	flex-cable retention bracket
4	top cover	8	display panel

## Removing the Display Bezel

- ➔ **NOTICE:** Disconnect the computer and any attached devices from electrical outlets, and remove any installed batteries.
  - ➔ **NOTICE:** To avoid ESD, ground yourself by using a wrist grounding strap or by touching an unpainted metal surface on the computer.
  - ➔ **NOTICE:** Read "[Preparing to Work Inside the Computer](#)" before performing the following procedure.
1. Remove the [hard drive](#).
  2. Remove the [display](#).
  3. Use a plastic scribe to pry the four rubber screw covers out of the screw holes located on the front of the bezel.
  4. Remove the four M2.5 x 5-mm screws located on the front of the bezel.
- ➔ **NOTICE:** Carefully separate the bezel from the top cover to avoid damage to the bezel.
5. Starting at the bottom of the display panel (by the DELL™ logo), use your fingers to separate the bezel from the top cover by lifting up the inside of the bezel while pushing in on the outside.

## Removing the Display Panel

- ➔ **NOTICE:** Disconnect the computer and any attached devices from electrical outlets, and remove any installed batteries.
  - ➔ **NOTICE:** To avoid ESD, ground yourself by using a wrist grounding strap or by touching an unpainted metal surface on the computer.
  - ➔ **NOTICE:** Read "[Preparing to Work Inside the Computer](#)" before performing the following procedure.
1. Remove the [hard drive](#).
  2. Remove the [display](#).
  3. Remove the [display bezel](#).
  4. Remove the [hinge covers](#).
  5. Remove the two M2 x 4-mm screws on the left side of the display panel and the two M2 x 4-mm screws on the right side of the display panel.
-  **HINT:** If you have a Hitachi display panel, remove the two M2 x 4-mm screws from the center of the left side of the display panel.
6. Remove the M2 x 4-mm screw that secures the display-feed flex cable to the display assembly through the black plastic flex-cable retention bracket.
  7. Lift the display panel from the top and rotate the display panel out of the top cover.
  8. Disconnect the bottom flex-cable connector from the inverter connector by pulling straight up on the attached pull-tab.

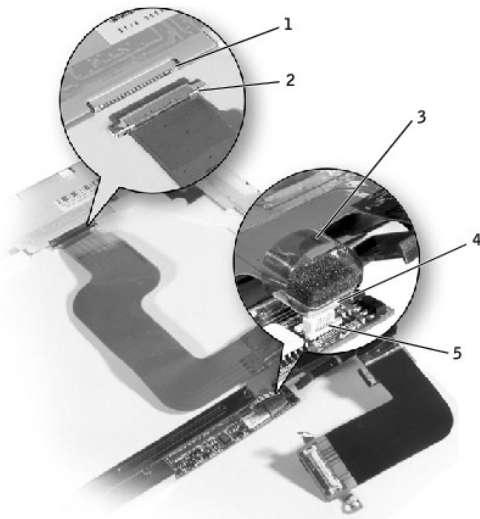

1	display panel connector
2	top flex-cable connector
3	pull-tab
4	bottom flex-cable connector
5	inverter connector

9. Remove the tape that secures the display panel connector and the tape that secures the middle of the display-feed flex cable to the display panel.

10. Pull the top flex-cable connector down and away to remove it from the display panel connector.

## Replacing the Display Panel

1. Reconnect the top flex-cable connector to the display panel connector.
  2. Reconnect the bottom flex-cable connector to the inverter connector.
  3. Replace the tape that secures the display panel connector and the tape that secures the middle of the display-feed flex cable to the display panel.
  4. Place the bottom edge of the display panel in the bottom of the top cover and elevate the top of the panel with your hand.
  5. Lay the display panel in the top cover.
  6. Reinstall the five M2 x 4-mm screws that secure the display panel to the top cover.
- 

## Display Latch

- ➡ **NOTICE:** Disconnect the computer and any attached devices from electrical outlets, and remove any installed batteries.
- ➡ **NOTICE:** To avoid ESD, ground yourself by using a wrist grounding strap or by touching an unpainted metal surface on the computer.

## Removing the Display Latch

1. Remove the [hard drive](#).
2. Remove the [display](#).
3. Remove the [display bezel](#).
4. Remove the two M2.5 x 5-mm screws and the two M1.7 x 3.5-mm screws that secure the display latch and bracket to the top cover.
5. Lift the display latch and bracket up and out of the top cover.

(XGA panel shown)

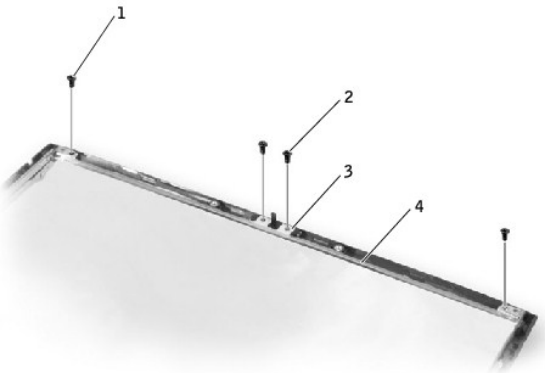

1	M1.7 x 3.5-mm screws (2)
2	M2.5 x 5-mm screws (2)
3	display latch
4	bracket

## Replacing the Display Latch

1. *On XGA panels,* place the display latch on top of its screw holes, and then place the bracket on top of the display latch, aligning the bracket and display latch screw holes.  
*On SXGA+ and UXGA panels,* align the screw holes and place the display latch and attached bracket in the top cover.
  2. Replace the two M2.5 x 5-mm screws and the two M1.7 x 3.5-mm screws that secure the display latch and bracket to the top cover.
- 

## Hinge Covers

### Removing the Hinge Covers

1. Remove the [display](#).
2. Rotate the hinges forward at an angle of approximately 90 degrees to the front of the display.
3. To remove the hinge covers, slide them off the hinges.

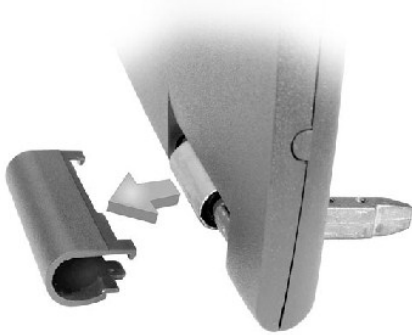

## Replacing the Hinge Covers

1. Attach the display to the bottom case.
2. Close the display.
3. Snap the hinge covers in place over the hinges.

 **HINT:** The right plastic hinge-cover label includes an "R," and the left plastic hinge-cover label includes an "L." The hinge-cover labels face the back of the computer.

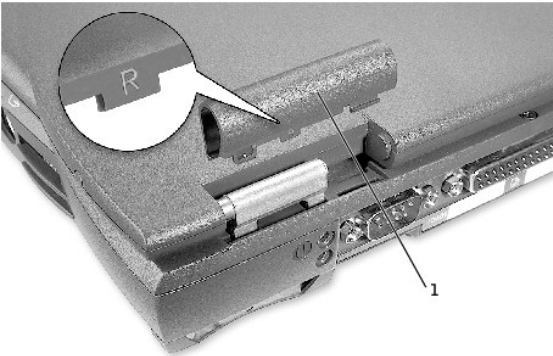

1	right hinge cover
2	left hinge cover



[Back to Contents Page](#)

# Reinstalling Drivers and Utilities

Dell™ Inspiron™ 4150

- [Overview](#)
- [Resolving Software and Hardware Incompatibilities](#)
- [Using Microsoft® Windows® XP System Restore](#)

---

## Overview

Dell ships your computer to you with required drivers and utilities already installed—no further installation or configuration is needed.

- 🔔 **NOTICE:** The *Drivers and Utilities* CD may contain drivers for operating systems that are not on your computer. Ensure that you are installing software appropriate for your operating system.

To reinstall drivers for optional devices such as wireless communications, DVD drives, and ZIP drives, you may need the CD and documentation that came with those devices.

- 🔔 **NOTICE:** The Dell | Support website, [support.dell.com](http://support.dell.com), and the *Drivers and Utilities* CD provide approved drivers for Dell™ computers. If you install drivers from other sources, your computer might not work correctly.

To reinstall a driver or utility from your *Drivers and Utilities* CD:

1. Save and close any open files, and exit any open programs.
2. Insert the *Drivers and Utilities* CD.

In most cases, the CD starts running automatically. If it does not, start Microsoft® Windows® Explorer, click your CD drive directory to display the CD contents, and then double-click the **autocd.exe** file. The first time that you run the CD, it might prompt you to install setup files. Click **OK**, and follow the instructions on the screen to continue.

3. From the **Language** drop-down menu in the toolbar, select your preferred language for the driver or utility (if available).

A welcome screen appears.

4. Click **Next**. The CD automatically scans your hardware to detect drivers and utilities used by your computer.

After the CD completes the hardware scan, you can also detect other drivers and utilities. Under **Search Criteria**, select the appropriate categories from the **System Model**, **Operating System**, and **Topic** drop-down menus.

A link or links appear(s) for the specific drivers and utilities used by your computer.

5. Click the link of a specific driver or utility to display information about the driver or utility that you want to install.
6. Click the **Install** button (if present) to begin installing the driver or utility. At the welcome screen, follow the screen prompts to complete the installation.

If no **Install** button is present, automatic installation is not an option. For installation instructions, either see the appropriate instructions in the following subsections, or click **Extract**, follow the extracting instructions, and read the readme file.

If instructed to navigate to the driver files, click the CD directory on the driver information window to display the files associated with that driver.

## Manually Reinstalling Drivers for Windows XP

- 🔔 **HINT:** If you are reinstalling an infrared sensor driver, you must first enable the infrared sensor in the system setup program (see "[Using the System Setup Program](#)") before continuing with the driver installation.

1. After extracting the driver files to your hard drive as described in the previous section, click the **Start** button, point to **Settings**, and then click **Control Panel**.
2. Click the **Start** button and right-click **My Computer**.
3. Click **Properties**.
4. Click the **Hardware** tab and click **Device Manager**.
5. Double-click the type of device for which you are installing the driver (for example, **Modems** or **Infrared devices**).
6. Double-click the name of the device for which you are installing the driver.
7. Click the **Driver** tab and then click **Update Driver**.
8. Select **Install from a list or specific location (Advanced)**, and then click **Next**.
9. Click **Browse**, and browse to the location to which you previously extracted the driver files.
10. When the name of the appropriate driver appears, click **Next**.
11. Click **Finish** and restart your computer.

## Using Microsoft Windows XP Device Driver Rollback

If you install a new device driver that causes system instability, you can use the Windows XP Device Driver Rollback utility to replace the new device driver with the previously installed version of the device driver. If you cannot reinstall your previous driver by using the Device Driver Rollback utility, then use [System Restore](#) to return your operating system to its previous operating state before you installed the new device driver. To use Device Driver Rollback:

1. Click the **Start** button and right-click **My Computer**.
  2. Click **Properties**.
  3. Click the **Hardware** tab and click **Device Manager**.
  4. In the **Device Manager** window, right-click the device for which the new driver was installed and then click **Properties**.
  5. Click the **Drivers** tab.
  6. Click **Roll Back Driver**.
- 

## Resolving Software and Hardware Incompatibilities

In the Microsoft® Windows® XP operating system, IRQ conflicts occur if a device either is not detected during the operating system setup or is detected but incorrectly configured. To check for IRQ conflicts on your computer:

1. Click the **Start** button and click **Control Panel**.
2. Click **Performance and Maintenance** and click **System**.
3. Click the **Hardware** tab and click **Device Manager**.
4. In the **Device Manager** list, check for conflicts with the other devices.

Conflicts are indicated by a yellow exclamation point (!) beside the conflicting device or a red X if the device has been disabled.

5. Double-click any conflicting device listed to bring up the **Properties** window so that you can determine what needs to be reconfigured or removed from the Device Manager.
6. Resolve these conflicts before checking specific devices.
7. Double-click the malfunctioning device type in the **Device Manager** list.
8. Double-click the icon for the specific device in the expanded list.

The **Properties** window appears.

If an IRQ conflict exists, the **Device status** area in the **Properties** window reports what other devices are sharing the device's IRQ.

9. Resolve any IRQ conflicts.

You can also use the Windows XP Hardware Troubleshooter. To use the troubleshooter, click the **Start** button and click **Help and Support**. Type **hardware troubleshooter** in the **Search** field, and then click the arrow to start the search. Click **Hardware Troubleshooter** in the **Search Results** list. In the **Hardware Troubleshooter** list, click **I need to resolve a hardware conflict on my computer**, and then click **Next**.

---

## Using Microsoft® Windows® XP System Restore

The Microsoft Windows XP operating system provides a System Restore utility that allows you to return your computer to an earlier operating state if changes to the computer's hardware, software (including new hardware or program installations), or system settings have left the computer in an undesirable operating state. You can also undo the last *system restore*.

System Restore automatically creates system checkpoints. You can also manually create your own checkpoints by creating *restore points*. To limit the amount of hard disk space used, older restore points will be automatically purged.

To resolve an operating system problem, you can use System Restore from Safe Mode or Normal Mode to return your computer to an earlier operating state.

System Restore does not cause you to lose personal files stored in the **My Documents** folder, data files, or e-mail messages after restoring the computer to an earlier time. If you restore the computer to an operating state that existed before you installed a program, the program's data files are not lost, but you must reinstall the actual program again.

 **NOTICE:** It is important to make regular backups of your data files. System Restore does not monitor changes to or recover your data files. If the original data on the hard disk is accidentally erased or overwritten, or if it becomes inaccessible because of a hard disk malfunction, use your backup files to recover the lost or damaged data.

System Restore is enabled on your new computer. However, if you reinstall Windows XP with less than 200 MB of free hard-disk space available, System Restore is automatically disabled. Before you use System Restore, confirm that it is enabled.

1. Click the **Start** button and click **Control Panel**.
2. Click the **Performance and Maintenance**.
3. Click **System**.
4. Click the **System Restore** tab.
5. Ensure that **Turn off System Restore** is not checked.

## Creating a Restore Point

In Windows XP, you can either use the System Restore Wizard or manually create a restore point.

### Using the System Restore Wizard

To use the System Restore Wizard, click the **Start** button, click **Help and Support**, click **System Restore**, and then follow the instructions in the **System Restore Wizard** window. You can also create and name a restore point if you are logged on as the computer administrator or a user with administrator rights.

### Manually Creating a Restore Point

1. Click the **Start** button, point to **All Programs**→**Accessories**→**System Tools**, and then click **System Restore**.
2. Click **Create a restore point**.
3. Click **Next**.
4. Type a name for the new restore point in the **Restore point description** field.

The present date and time are automatically added to the description of the new restore point.

5. Click **Create**.
6. Click **OK**.

## Restoring the Computer to an Earlier Operating State

If problems occur after installing a device driver, first try using [Device Driver Rollback](#). If Device Driver Rollback does not resolve the problem, then use System Restore.

 **NOTICE:** Before restoring the computer to an earlier operating state, save and close all open files and exit all open programs. Do not alter, open, or delete any files or programs until the system restoration is complete.

1. Click the **Start** button, point to **All Programs**→**Accessories**→**System Tools**, and then click **System Restore**.
2. Ensure that **Restore my computer to an earlier time** is selected and click **Next**.
3. Click a calendar date to which you want to restore your computer.

The **Select a Restore Point** screen provides a calendar that allows you to see and select restore points. All calendar dates with available restore points appear in bold.

4. Select a restore point and click **Next**.

If a calendar date has only one restore point, then that restore point is automatically selected. If two or more restore points are available, click the restore point that you want to use.

5. Click **Next**.

The **Restoration Complete** screen appears after System Restore finishes collecting data, and then the computer automatically restarts.

6. After the computer restarts, click **OK**.

To change the restore point, you can either repeat the steps using a different restore point, or you can undo the restoration.

## Undoing the Last System Restore

 **NOTICE:** Save and close all open files and exit all open programs. Do not alter, open, or delete any files or programs until the system restoration is complete.

1. Click the **Start** button, point to **All Programs**→**Accessories**→**System Tools**, and then click **System Restore**.
2. Select **Undo my last restoration** and click **Next**.
3. Click **Next**.

The **System Restore** screen appears, and then the computer automatically restarts.

4. After the computer restarts, click **OK**.

## Hybrid Cooling Fan

Dell™ Inspiron™ 4150

---

### Removing the Hybrid Cooling Fan

- ➔ **NOTICE:** Disconnect the computer and any attached devices from electrical outlets, and remove any installed batteries.
- ➔ **NOTICE:** To avoid ESD, ground yourself by using a wrist grounding strap or by touching an unpainted metal surface on the computer.
- ➔ **NOTICE:** Read "[Preparing to Work Inside the Computer](#)" before performing the following procedure.

1. Remove the [hard drive](#).
2. Remove the [keyboard](#).
3. Remove the [display](#).
4. Remove the [palm rest](#).
5. Remove the [microprocessor thermal cooling assembly](#).
6. Remove the two M2.5 x 5-mm screws and one M2 x 3-mm screw that secure the hybrid cooling fan to the system board.

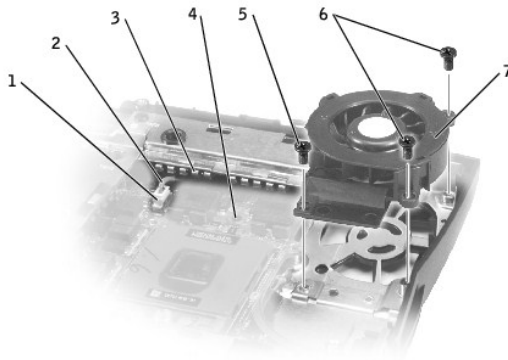

1	system-board interface connector	5	M2 x 3-mm screw (1)
2	fan power cable	6	M2.5 x 5-mm screws (2)
3	spring fingers	7	hybrid cooling fan
4	keyboard screw hole		

7. Disconnect the fan power cable from the system-board interface connector and remove the hybrid cooling fan.

🔍 **HINT:** The fan power cable is long, and can be pulled out from under the EMI shield to provide access to the connector.





- ➔ **NOTICE:** Do not block the keyboard screw hole when reinstalling the fan. Route the fan power cable under the spring fingers and behind the keyboard screw hole to prevent damage to the fan power cable.
-

## Hard Drive

Dell™ Inspiron™ 4150

---

### Removing the Hard Drive

-  **CAUTION:** If you remove the hard drive from the computer when the drive is hot, *do not touch* the metal housing of the hard drive.
  -  **NOTICE:** Disconnect the computer and any attached devices from electrical outlets, and remove any installed batteries.
  -  **NOTICE:** The hard drive is very sensitive to shock. Handle the hard drive by its edges (do not squeeze the top of the hard drive case), and avoid dropping it.
  -  **NOTICE:** Read "[Preparing to Work Inside the Computer](#)" before performing the following procedure.
  -  **NOTICE:** To prevent data loss, turn off your computer before removing the hard drive. Do not remove the hard drive while the computer is running, in standby mode, or in hibernate mode.
1. Save and close any open files, exit any open programs, and shut down the computer.
  2. Ground yourself by touching a metal connector on the back of the computer.
  3. Turn the computer over. Remove the M3 x 5-mm screw from the hard drive door.

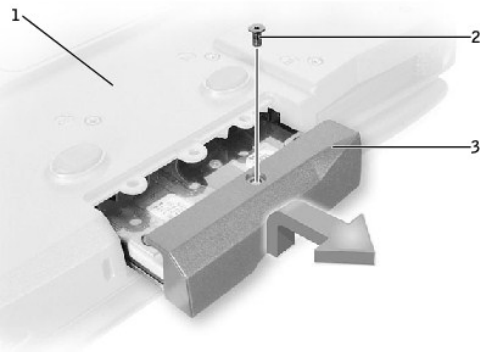

1	bottom of computer
2	M3 x 5-mm screw
3	hard drive door

4. Lift the hard drive door until you hear a click.
5. Slide the hard drive out of the computer.

### Replacing the Hard Drive

-  **NOTICE:** Use firm and even pressure to slide the hard drive into place. If you force the hard drive into place using excessive force, you may damage the connector.
1. Lift the hard drive door until you hear a click. Push the hard drive into the drive bay until it is fully seated in the bay.
  2. Press the hard drive door down.
  3. Replace the M3 x 5-mm screw in the hard drive door.
-

## Palm Rest and Display Cover Inserts

Dell™ Inspiron™ 4150

- [Palm Rests](#)
  - [Display Cover](#)
- 

### Palm Rests

 **HINT:** Complete instructions for installing the palm rests are included with the optional color inserts.

1. Save and close any open files, exit any open programs, and shut down the computer.
2. If the computer is connected to a docking device (docked), undock it. See the documentation that came with your docking device for instructions.
3. Keep the display open and tilt the computer back so that you can access the bottom of the computer.
4. Slide and hold the latch release on the left side, and remove any device installed in the module bay.
5. Slide and hold the latch release on the right side, and remove any battery installed in the battery bay.
6. Locate the orange palm rest removal buttons. Firmly press the buttons with the eraser end of a pencil (or a dull utensil smaller than your finger) to release the palm rests.

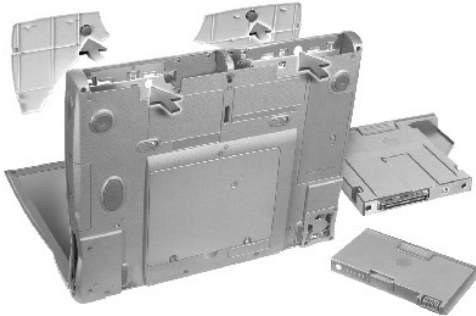

7. Remove the palm rests.
8. To replace the palm rests, insert the tabs on the inside edge of the palm rest into the slots on the computer. Then press along the outside edges of the palm rest until it snaps into place.

Repeat the process on each side.



---

### Display Cover

 **HINT:** Complete instructions for installing the display cover are included with the optional color inserts.

1. Slide your index fingers under the straight edge of the display cover until the cover pops out.

2. Slide the display cover towards the back of the computer.
3. Use your fingers to release the cover completely, and remove it.



4. To replace the display cover, bend it slightly to insert the four tabs on the rounded edge of the cover into the slots on the top of the computer.
5. Press the cover along the straight edge at the back of the computer until it snaps into place.
6. Firmly press the Dell™ logo until it snaps into place. Press above both hinge covers to engage the final snaps.

---

[Back to Contents Page](#)



## Keyboard

Dell™ Inspiron™ 4150

### Removing the Keyboard

- ➔ **NOTICE:** Disconnect the computer and any attached devices from electrical outlets, and remove any installed batteries.
- ➔ **NOTICE:** To avoid ESD, ground yourself by using a wrist grounding strap or by touching an unpainted metal surface on the computer.
- ➔ **NOTICE:** Read "[Preparing to Work Inside the Computer](#)" before performing the following procedure.

1. Remove the [hard drive](#).
2. Turn the computer over, and remove the five M2.5 x 12-mm screws labeled "circle K."

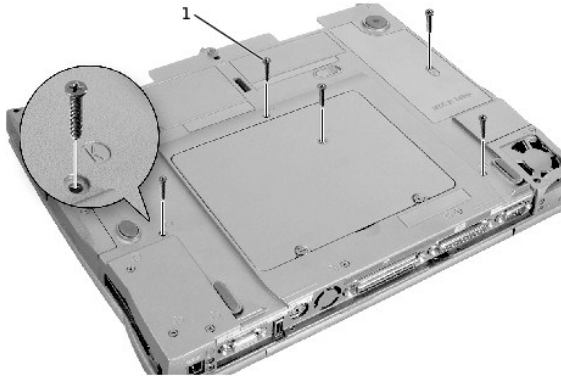

1	M2.5 x 12-mm screws (5)
---	-------------------------

3. Turn the computer over and open the display.

➔ **NOTICE:** The key caps on the keyboard are fragile, easily dislodged, and time-consuming to replace. Be careful when removing and handling the keyboard.

4. Remove the center control cover:
  - a. Use a small, flat-blade screwdriver or plastic scribe to lift the right edge of the center control cover and pry it loose from the bottom case.
  - b. Lift the center control cover up and away from the bottom case.



5. To release the keyboard from the palm rest, use a small, flat-blade screwdriver or plastic scribe to pull up on the right edge of the blank key on the keyboard.

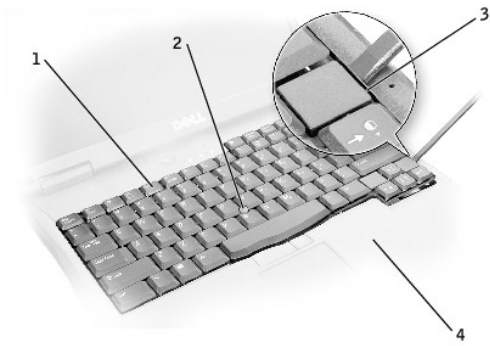

1	keyboard
2	track stick
3	blank key
4	palm rest

6. Lift the keyboard straight up until it clears the keyboard boss support in the bottom case.
7. Rotate the keyboard forward toward the front of the computer.
8. Rest the key face of the keyboard on the palm rest.

➔ **NOTICE:** Do not pull on the keyboard flex and track stick cables.

9. Pull up on the keyboard connector to disconnect it from the interface connector on the system board.

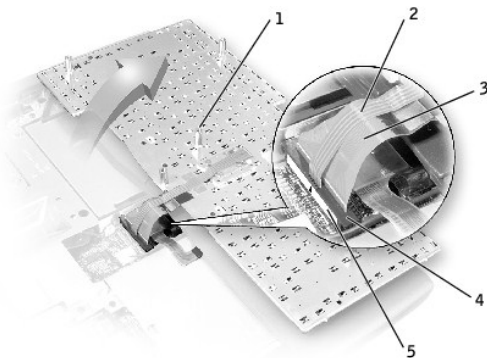

1	boss support (5)
2	track stick cable
3	keyboard flex cable
4	keyboard connector
5	orientation label

10. Remove the keyboard from the bottom case.

## Replacing the Keyboard

1. Place the keyboard on the palm rest at the front of the computer with the keys face down and the connector toward the back of the computer.

➔ **NOTICE:** To avoid damage to the connector pins, press the keyboard connector evenly into the interface connector on the system board, and do not reverse the keyboard connector.

2. Connect the keyboard connector to the interface connector on the system board.

The keyboard connector may have a label on it that shows the correct orientation of the keyboard connector to the system-board interface connector.

3. Carefully turn the keyboard over. Align the keyboard boss support, fit the left side of the keyboard into place, and then snap the right side of the keyboard into place.

➔ **NOTICE:** Position the keyboard flex and track stick cables so that they are not pinched when you replace the keyboard in the bottom case.

4. Check that the keyboard is correctly installed. The keys should be flush with the left and right surfaces of the palm rest.
  5. Replace the center control cover, close the display assembly, and turn the computer over.
  6. Reinstall the five M2.5 x 12-mm screws in the holes labeled "circle K."
- 

[Back to Contents Page](#)

## Palm Rest

Dell™ Inspiron™ 4150

- ➔ **NOTICE:** Disconnect the computer and any attached devices from electrical outlets, and remove any installed batteries.
- ➔ **NOTICE:** To avoid ESD, ground yourself by using a wrist grounding strap or by touching an unpainted metal surface on the computer.
- ➔ **NOTICE:** Read "[Preparing to Work Inside the Computer](#)" before performing the following procedure.

1. Remove the [hard drive](#).
2. Remove the [keyboard](#).

- ➔ **NOTICE:** You must remove the display before you remove the palm rest; the display hinges pass through the back of the palm rest.

3. Remove the [display](#) and [hinge covers](#).
4. Turn the computer over and remove the three M2.5 x 12-mm screws labeled "circle P."

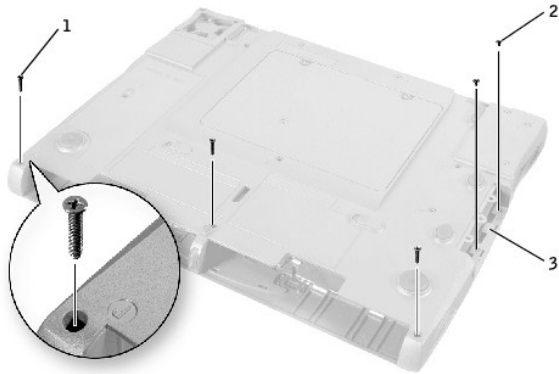

1	M2.5 x 12-mm screws (3)
2	M2 x 3-mm screws (2)
3	hard drive door

5. Remove the two M2 x 3-mm screws that are located in the hard drive door labeled "circle P."
6. Turn the computer over, and remove the three M2 x 3-mm screws that secure the palm rest to the bottom case:
  - a. Remove the two M2 x 3-mm screws that are located on the back edge of the bottom case, underneath the display.
  - b. Remove the M2 x 3-mm screw located underneath the keyboard, on the right side of the bottom case, next to the microprocessor thermal cooling assembly and opposite the S-video TV-out connector.
7. Pull up on the pull-tab that is attached to the palm-rest flex cable connector to remove it from the interface connector on the system board.

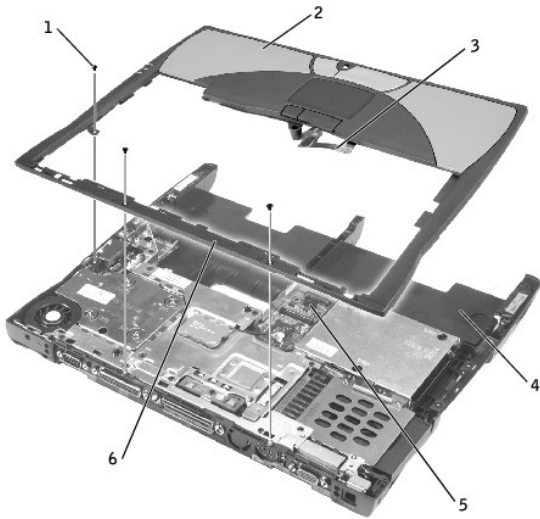

1	M2 x 3-mm screws (3)
2	palm rest
3	palm-rest flex cable
4	bottom case
5	touch pad connector
6	back center of the palm rest

 **NOTICE:** Carefully separate the palm rest from the bottom case to avoid damage to the palm rest.

8. Starting at the back center of the palm rest, use your fingers to separate the palm rest from the bottom case by lifting the inside of the palm rest while pushing in on the outside.

---

[Back to Contents Page](#)

[Back to Contents Page](#)

## Pin Assignments for I/O Connectors

Dell™ Inspiron™ 4150

- [Port Locations](#)
- [Serial Connector](#)
- [Parallel Connector](#)
- [Docking Connector](#)
- [PS/2 Connector](#)
- [USB Connector](#)
- [Video Connector](#)
- [S-Video TV-Out Connector](#)

### Port Locations

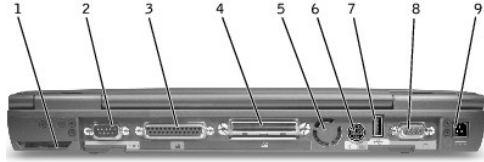

1	air intake	6	PS/2 connector
2	serial connector	7	USB connector
3	parallel connector	8	video connector
4	docking connector	9	AC adapter connector
5	air vent		

### Serial Connector

Use the 9-pin serial connector to attach a serial device to the computer. The serial connector passes data in serial format (1 bit at a time over one line). This connector supports a variety of devices, including a serial mouse, that require serial data transmission. If you reconfigure your hardware, you may need pin number and signal information for the serial connector.



Pin	Signal	I/O	Definition
1	DCD	I	Data carrier detect
2	RXDA	I	Receive data
3	TXDA	O	Transmit data
4	DTR	O	Data terminal ready
5	GND	N/A	Signal ground
6	DSR	I	Data set ready
7	RTS	O	Request to send
8	CTS	I	Clear to send
9	RI	I	Ring indicator
Shell	N/A	N/A	Frame ground

### Parallel Connector

Use the 25-hole parallel connector to attach a parallel device to the computer. The parallel connector is used primarily for printers. The parallel connector transmits data in parallel format, where 8 data bits (one byte) are sent simultaneously over eight separate lines.

The parallel connector can also be configured for compatibility with the PS/2 standard. Support for the EPP feature improves network adapter performance (adapters connect to the computer's parallel connector and require the appropriate software drivers from the adapter's manufacturer).

If you reconfigure your hardware, you may need pin number and signal information for the parallel connector.



13 12 11 10 9 8 7 6 5 4 3 2 1  
25 24 23 22 21 20 19 18 17 16 15 14

Pin	Signal	I/O	Definition
1	STB#	I/O	Strobe
2	D0	I/O	Printer data bit 0
3	PD1	I/O	Printer data bit 1
4	PD2	I/O	Printer data bit 2
5	PD3	I/O	Printer data bit 3
6	PD4	I/O	Printer data bit 4
7	PD5	I/O	Printer data bit 5
8	PD6	I/O	Printer data bit 6
9	PD7	I/O	Printer data bit 7
10	ACK#	I	Acknowledge
11	BUSY	I	Busy
12	PE	I	Paper end
13	SLCT	I	Select
14	AFD#	O	Automatic feed
15	ERR#	I	Error
16	INIT#	O	Initialize printer
17	SLIN#	O	Select in
18-25	N/A	N/A	Ground signal
Shell	N/A	N/A	Frame ground

## Docking Connector

Use this connector to attach your computer to the optional docking device.

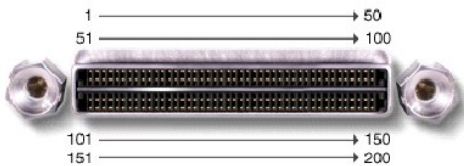

Pin	Signal	Pin	Signal	Pin	Signal	Pin	Signal
1	STRB#/5V	51	HSYNC	101	VGA_GRN	151	GND
2	PD0	52	VSYNC	102	GND	152	CLK_SPCI
3	PD1	53	GND	103	VGA_RED	153	GND
4	PD2	54	DOCKED	104	GND	154	SAD0
5	PD3	55	USB_VD1+	105	VGA_BLU	155	SAD1
6	PD4	56	USB_VD1-	106	DOCK_SD/MODE	156	SAD2
7	PD5	57	GND	107	D_IRTX	157	SAD3
8	PD6	58	USB_VD2+	108	D_IRRX	158	SAD4
9	PD7	59	USB_VD2-	109	GND	159	SAD5
10	GND	60	DOCKOC1#	110	SPIROB#	160	SAD6
11	DOC_SPKR	61	RUN_ON#	111	SPIROC#	161	GND
12	DOCK_MIC	62	GND	112	DAT_DDC2	162	SAD7
13	DOCK_LINE	63	NC	113	CLK_DDC2	163	SAD8
14	DOCK_CDROM	64	DOCK_SCLK	114	SPAR	164	SC/BE0#
15	GND	65	DOCK_LRCK	115	SPME#	165	SAD9

16	M_SEN#	66	DOCK_MCLK	116	GND	166	SAD10
17	POWER_SW#	67	GND	117	SSERR#	167	SAD11
18	OPCIEN#	68	+12V	118	SPERR#	168	SAD12
19	S1.6M_EN#	69	AFD#	119	SLOCK#	169	GND
20	DFDD/LPT#	70	ERROR#	120	SSTOP#	170	SAD13
21	GND	71	ACK#	121	GND	171	SAD14
22	NC	72	GND	122	SDEVSEL#	172	SAD15
23	NC	73	INIT#	123	STRDY#	173	SAD16
24	D_ATCTLED	74	SLCT_IN#	124	SIRDY#	174	SC/BE1#
25	D_PWRLED	75	BUSY	125	SFRAME#	175	SC/BE2#
26	DOCK_PWR_SRC	76	PE	126	SCLKRUN#	176	GND
27	DOCK_PWR_SRC	77	SLCT	127	GND	177	SAD17
28	DOCK_PWR_SRC	78	GND	128	SGNTA#	178	SAD18
29	GND	79	DAT_SMB	129	SREQA#	179	SAD19
30	+5VDOCK	80	DCLK_SMB	130	SGNT0#	180	SAD20
31	+5VDOCK	81	SMB_INIT#	131	SREQ0#	181	SAD21
32	+5VDOCK	82	GND	132	SPCIRST#	182	GND
33	+5VDOCK	83	DAT_DOCSM1	133	SH1SEL#	183	SAD22
34	+5VDOCK	84	CLK_DOCSM1	134	GND	184	SAD23
35	GND	85	DAT_DOCKBD	135	SWRPRT#	185	SAD24
36	DOCK_PWR_SRC	86	CLK_DOCKBD	136	SDSKCHG#/DRQ	186	SC/BE3#
37	DOCK_PWR_SRC	87	GND	137	SDIR#	187	SAD25
38	DOCK_PWR_SRC	88	R10	138	STRK0#	188	GND
39	DOCK_PWR_SRC	89	CTS0	139	SSTEP#	189	SAD26
40	GND	90	RTS0	140	SDRV1#	190	SAD27
41	DOCK_+DC_IN	91	DSR0	141	GND	191	SAD28
42	DOCK_+DC_IN	92	GND	142	SMRT1#	192	SAD29
43	DOCK_+DC_IN	93	DTR0	143	SWRDATA#	193	SAD30
44	DOCK_+DC_IN	94	TXD0#	144	SWGATE#	194	SAD31
45	DOCK_+DC_IN	95	RXD0#	145	SRDATA#	195	GND
46	DOCK_+DC_IN	96	DCD0	146	SINDEX#	196	NC
47	DOCK_+DC_IN	97	NC	147	GND	197	NC
48	DOCK_+DC_IN	98	+5VSUS	148	NC	198	NC
49	GND	99	NC	149	+5VALW	199	NC
50	LOW_PWR	100	NC	150	NC	200	GND

## PS/2 Connector

Use the 6-hole, miniature DIN PS/2 connector to attach PS/2-compatible devices such as a mouse, keyboard, or external numeric keypad. If you reconfigure your hardware, you may need pin number and signal information for the PS/2 connector.

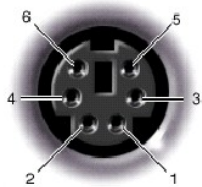

Pin	Signal	I/O	Definition
1	EXK_MSDATA	I/O	External keyboard/keypad/mouse data
2	KBD_DATA	I	Keyboard data
3	GND	N/A	Signal ground
4	EXK_MSPWR	N/A	External keyboard/keypad/mouse supply voltage
5	EXK_MSCLK	I/O	External keyboard/keypad/mouse clock
6	KBD_CLK	I	Keyboard clock
Shell	N/A	N/A	Chassis ground



---

## USB Connector

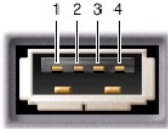

Use the USB connector to attach one or more USB devices, such as a mouse, to the computer. USB is a peripheral standard that enables automatic detection of USB-compliant peripheral devices.



Pin	Signal	Definition
1	VCC	Cable power
2	- Data	N/A
3	+Data	N/A
4	Ground	Cable ground

---

## Video Connector

Use the 15-pin video connector to attach an external monitor to the computer. If the image does not appear on the monitor immediately, press  .



Pin	Signal	I/O	Definition
1	RED	O	Red video
2	GREEN	O	Green video
3	BLUE	O	Blue video
4	DDC2_MONID2	I	Monitor detect ID2
5	GND	N/A	Signal ground
6	GND	N/A	Signal ground
7	GND	N/A	Signal ground
8	GND	N/A	Signal ground
9	CRTVCC	O	5-V power source for CRT
10	GND	N/A	Signal ground
11	M-SEN#	I	Digital monitor sense/monitor detect ID1
12	DDC_DATA	I	Monitor detect serial data
13	HSYNC	O	Horizontal synchronization
14	VSYSN	O	Vertical synchronization
15	DDC_CLK	1	Monitor Detect serial clock
Shell	N/A	N/A	Frame ground

---

## S-Video TV-Out Connector

Use this connector to connect your computer to a television.

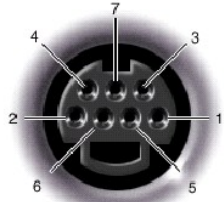

S-Video	
Pin	Signal
1	GND
2	GND
3	DLUMA-L
4	DCRMA-L

Composite Video	
Pin	Signal
5	NC
6	DCMPS-L
7	GND

---

[Back to Contents Page](#)

# Power Management

Dell™ Inspiron™ 4150

- [Power Management Tips](#)
  - [Power Management Modes](#)
  - [Power Options Properties](#)
- 

## Power Management Tips

 **HINT:** See "Using a Battery" in the *Tell Me How* help file for more information on conserving battery power (see "[Accessing Help](#)").

- 1 Connect the computer to an electrical outlet when possible because the battery life expectancy is largely determined by the number of times the battery is charged.
  - 1 Place the computer in [standby mode](#) or [hibernate mode](#) when you leave the computer unattended for long periods of time.
  - 1 To exit a power management mode, press the power button.
- 



## Power Management Modes

### Standby Mode

Standby mode conserves power by turning off the display and the hard drive after a predetermined period of inactivity (a time-out). When the computer exits standby mode, it returns to the same operating state it was in before entering standby mode.

 **NOTICE:** If your computer loses AC and battery power while in standby mode, it may lose data.

To enter standby mode:

- 1 Click the **Start** button, click **Turn off computer**, and then click **Stand by**.
- or
- 1 Depending on how you set the power management options on the [Advanced tab](#) in the **Power Options Properties** window, use one of the following methods:
    - o Press the power button.
    - o Close the display.
    - o Press  .

To exit standby mode, press the power button or open the display depending on how you set the options on the [Advanced tab](#). You cannot make the computer exit standby mode by pressing a key or touching the touch pad or track stick.



### Hibernate Mode

Hibernate mode conserves power by copying system data to a reserved area on the hard drive and then completely turning off the computer. When the computer exits hibernate mode, it returns to the same operating state it was in before entering hibernate mode.

 **NOTICE:** You cannot remove devices or undock your computer while your computer is in hibernate mode.

Your computer enters hibernate mode if the battery charge level becomes critically low.

Depending on how you set the power management options on the [Advanced tab](#) in the **Power Options Properties** window, use one of the following methods to enter hibernate mode:

- 1 Press the power button.
- 1 Close the display.
- 1 Press  .

 **HINT:** Some PC Cards may not operate correctly after the computer exits hibernate mode. Remove and reinsert the card, or simply restart (reboot) your computer.

To exit hibernate mode, press the power button. The computer may take a short time to exit hibernate mode. You cannot make the computer exit hibernate mode by pressing a key or touching the touch pad or track stick. For more information on hibernate mode, see the documentation that came with your operating system.

---

## Power Options Properties

To access the Microsoft® Windows® **Power Options Properties** window:

1. Click the **Start** button and click **Control Panel**.
2. Under **Pick a category**, click **Performance and Maintenance**.
3. Under **or pick a Control Panel icon**, click **Power Options**.

### Power Schemes Tab

The **Power schemes** drop-down menu displays the selected preset power scheme. Depending on your operating system, typical power schemes are:

- 1 **Portable/Laptop**
- 1 **Home/Office**
- 1 **Always On**
- 1 **Presentation**
- 1 **Minimal Power Management**
- 1 **Max Battery**

 **HINT:** Use the **Portable/Laptop** power scheme to maximize battery power.

Windows XP controls the performance level of the processor depending on the power scheme you select. You do not need to make any further adjustments to set the performance level.

Each preset power scheme has different time-out settings for entering standby mode, turning off the display, and turning off the hard drive. For more information on power management options, see the Windows XP Help and Support Center (see "[Accessing Help](#)").

### Alarms Tab

 **HINT:** To enable audible alarms, click each **Alarm Action** button and select **Sound alarm**.

The **Low battery alarm** and **Critical battery alarm** settings alert you with a message when the battery charge falls below a certain percentage. When you receive your computer, the **Low battery alarm** and **Critical battery alarm** check boxes are selected. Dell recommends that you continue to use these settings.

### Power Meter Tab

The **Power Meter** tab displays the current power source and amount of battery charge remaining.

### Advanced Tab

The **Advanced** tab allows you to:

- 1 Set power icon and standby mode password options.
- 1 Program the following functions (depending on your operating system):
  - o Prompt a user for an action (**Ask me what to do**).
  - o Enter standby mode.
  - o Enter hibernate mode.
  - o Shut down Windows and turn off the computer.
  - o Choose no action (**None** or **Do nothing**).

To program these functions, click an option from the corresponding drop-down menu and then click **OK**.

### Hibernate Tab

The **Hibernate** tab lets you enable hibernate mode by clicking the **Enable hibernate support** check box.

---

[Back to Contents Page](#)

[Back to Contents Page](#)

## Removing and Replacing Parts

**Dell™ Inspiron™ 4150**

- [Before You Remove or Replace Parts](#)
  - [System Components](#)
  - [Palm Rest and Display Cover Inserts](#)
  - [Hard Drive](#)
  - [Memory Modules, Mini PCI Card, and Modem](#)
  - [Keyboard](#)
  - [Display, Display Assembly, Display Latch, and Hinge Covers](#)
  - [Palm Rest](#)
  - [Microprocessor Thermal Cooling Assembly](#)
  - [Microprocessor](#)
  - [Hybrid Cooling Fan](#)
  - [Reserve Battery](#)
  - [Speakers](#)
  - [System Board](#)
  - [Battery and Module Bay Latches](#)
- 

[Back to Contents Page](#)

## Reserve Battery

Dell™ Inspiron™ 4150

---

### Removing the Reserve Battery

- ➔ **NOTICE:** The reserve battery provides power to the computer's RTC and NVRAM when the computer is turned off. Removing the battery causes the computer to lose the date and time information as well as all user-specified parameters in the BIOS. If possible, make a copy of this information before you remove the reserve battery.
  - ➔ **NOTICE:** Disconnect the computer and any attached devices from electrical outlets, and remove any installed batteries.
  - ➔ **NOTICE:** To avoid ESD, ground yourself by using a wrist grounding strap or by touching an unpainted metal surface on the computer.
  - ➔ **NOTICE:** Read "[Preparing to Work Inside the Computer](#)" before performing the following procedure.
1. Remove the [hard drive](#).
  2. Remove the [keyboard](#).
  3. Disconnect the reserve battery cable from the system board connector.
  4. Pry the reserve battery free from the system board. The reserve battery is attached to the system board with a piece of adhesive tape.
  5. Remove any remnants of the adhesive tape from the EMI shield.

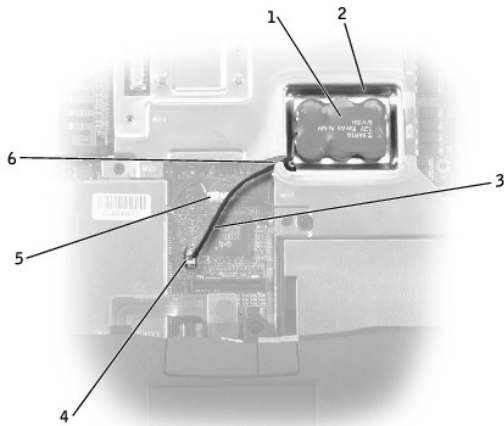

1	reserve battery
2	reserve battery tray
3	reserve battery cable
4	reserve battery connector
5	speaker cable
6	opening for reserve battery cable

### Replacing the Reserve Battery

1. Connect the reserve battery cable to the system board connector, and then route the battery cable through the opening in the EMI shield to the battery tray.
  2. Remove the backing from the adhesive on the bottom of the reserve battery, and press the battery into place in the battery tray.
  3. [Update the BIOS](#) using the flash BIOS update program CD.
-

[Back to Contents Page](#)

# Using the System Setup Program

Dell™ Inspiron™ 4150

- [Overview](#)
  - [Viewing the System Setup Screens](#)
  - [System Setup Screens](#)
  - [Commonly Used Options](#)
- 

## Overview

The system setup program contains the standard settings for your computer.



**NOTICE:** Unless you are an expert computer user or are directed to do so by Dell technical support, do not change the settings for this program. Certain changes might make your computer work incorrectly.

---

## Viewing the System Setup Screens

1. Turn on (or restart) your computer.
2. When the Dell™ logo appears, press  immediately.

If you wait too long and the Windows logo appears, continue to wait until you see the Windows desktop. Then shut down your computer and try again.

---

## System Setup Screens



**HINT:** To see information about a specific item on a system setup screen, highlight the item and refer to the **Help** area on the screen.

The system setup screens display the current setup information and settings for your computer. On each screen, the system setup options are listed at the left. To the right of each option is a field that displays the setting or value for that option. You can change settings that appear as white type on the screen. Options or values that you cannot change (because they are determined by the computer) appear less bright.

A box in the upper-right corner of the screen displays help information for the currently highlighted option; a box in the lower-right corner displays information about the computer. System setup key functions are listed across the bottom of the screen.

The screens display such information as:

- 1 System configuration
  - 1 Boot Order
  - 1 Boot (start-up) configuration and docking-device configuration settings
  - 1 Basic device configuration settings
  - 1 Battery charge status
  - 1 Power management settings
  - 1 System security and hard-drive password settings
- 

## Commonly Used Options



**HINT:** Certain options require that you reboot the computer for new settings to take effect.

## Changing the Boot Sequence



The *boot sequence*, or *boot order*, tells the computer where to look to find the software needed to start the operating system. You can control the boot sequence using the **Boot Order** page of the system setup program.

The **Boot Order** page displays a general list of the bootable devices that may be installed in your computer, including but not limited to the following:

- 1 **Diskette Drive**
- 1 **Modular bay HDD**
- 1 **Internal HDD**
- 1 **CD/DVD/CD-RW drive**

During the boot routine, the computer starts at the top of the list and scans each enabled device for the operating system start-up files. When the computer finds the files, it stops searching and starts the operating system.

To control the boot sequence, you can select (highlight) devices (by pressing the  and  keys) and then enable or disable the device or change their order in the list.

1. To enable or disable a device, highlight the item and press . Enabled items appear as white and display a small triangle to the left; disabled items appear blue or dimmed without a triangle.
1. To reorder a device in the list, highlight the device and then press  or  (not case-sensitive) to move the highlighted device up or down.

Boot sequence changes take effect as soon as you save the changes and exit the system setup program.

## Performing a One-Time Boot

You can set a one-time-only boot sequence without going into the system setup program. (You can also use this procedure to boot to the Dell Diagnostics on the Diagnostics utility partition on your hard drive.)

1. Turn off the computer.
2. If the computer is connected to a docking device (docked), undock it. See the documentation that came with the docking device for instructions.
3. Connect the computer to an electrical outlet.
4. Turn on the computer. When the Dell logo appears, press  immediately.

If you wait too long and the Windows® logo appears, continue to wait until you see the Windows desktop. Then shut down your computer and try again.

5. When the boot device list appears, highlight the device from which you want to boot and press .

The computer boots to the selected device.

The next time you reboot the computer, the normal boot order is restored.

 **HINT:** You can only boot (start up) your computer from a CD, CD-RW, or DVD drive installed as a fixed optical drive. You cannot boot from one of these modules installed in the module bay.

## Changing Printer Modes

Set the **Parallel Mode** option according to the type of printer or device connected to the parallel connector. To determine the correct mode to use, see the documentation that came with the device.

Setting **Parallel Mode** to **Disabled** disables the parallel port and the port's LPT address, freeing its interrupt for another device to use.

## Changing COM Ports

**Serial Port** allows you to map the serial port COM address or disable the serial port and its address, freeing that interrupt for another device to use.

---

[Back to Contents Page](#)



## Solving Problems

### Dell™ Inspiron™ 4150

- [Accessing Help](#)
- [Power Problems](#)
- [Error Messages](#)
- [Video and Display Problems](#)
- [Sound and Speaker Problems](#)
- [Printer Problems](#)
- [Modem and Internet Connection Problems](#)
- [Scanner Problems](#)
- [Touch Pad or Mouse Problems](#)
- [External Keyboard Problems](#)
- [Unexpected Characters](#)
- [Drive Problems](#)
- [PC Card Problems](#)
- [Network Problems](#)
- [General Program Problems](#)
- [E-Mail Problems](#)
- [If Your Computer Gets Wet](#)
- [If You Drop or Damage Your Computer](#)
- [Resolving Other Technical Problems](#)

---

## Accessing Help

### To access the Tell Me How help file —

1. Click the **Start** button and then click **Help and Support**.
2. Click **User and system guides** and then click **User's guides**.
3. Click **Tell Me How**.

### To access help in Microsoft® Windows® XP —

1. Click the **Start** button and then click **Help and Support**.
2. Type a word or phrase that describes your problem and then click the arrow icon.
3. Click the topic that describes your problem.
4. Follow the instructions shown on the screen.

---

## Power Problems

 **HINT:** See the *Tell Me How* help file for information on power management modes (see "[Accessing Help](#)").

**Check the power light —** When the power light is lit or blinking, the computer has power. If the light is blinking, the computer is in standby mode—press the power button to exit a standby mode. If the light is off, the computer is either in a power management mode or off—press the power button to exit a power management mode or to turn on the computer.

**Charge the battery —** The battery charge may be depleted.

1. Reinstall the battery.
2. Use the AC adapter to connect the computer to an electrical outlet.
3. Turn on the computer.

**Check the battery status light —** If the battery status light flashes orange or is a steady orange, the battery charge is low or depleted. Connect the computer to an electrical outlet.

If the battery status light flashes green and orange, the battery is too hot to charge. Shut down the computer, disconnect the computer from the electrical outlet, and then let the battery and computer cool to room temperature.

If the battery status light rapidly flashes orange, the battery may be defective. Contact Dell. See your *Owner's Manual* for contact information.

**Test the electrical outlet —** Ensure that the electrical outlet is working by testing it with another device, such as a lamp.

**Check the AC adapter —** Check the AC adapter cable connections. If the AC adapter has a light, ensure that the light is on.

**Connect the computer directly to an electrical outlet —** Bypass power protection devices, power strips, and the extension cable to verify that the computer turns on.

**Eliminate possible interference —** Turn off nearby fans, fluorescent lights, halogen lamps, or other appliances.

**Adjust the power properties —** Your computer may be in standby or hibernate mode. For information on power management modes, see the *Tell Me How* help file, or search for the keyword *standby* or *hibernate* in the Windows XP Help and Support Center (see "[Accessing Help](#)").

**Reseat the memory modules —** If the computer power light turns on but the display remains blank, [reseat the memory modules](#).

## Error Messages







If the message is not listed, see the documentation for the operating system or the program that was running at the time the message appeared.

<b>The file being copied is too large for the destination drive</b> — The file that you are trying to copy is too large to fit on the disk, or the disk is too full. Try copying the file to a different disk or use a larger capacity disk.
<b>A filename cannot contain any of the following characters: \ / : * ? " &lt; &gt;  </b> — Do not use these characters in filenames.
<b>Insert bootable media</b> — The operating system is trying to boot to a nonbootable floppy disk or CD. Insert a bootable floppy disk or CD.
<b>Non-system disk or disk error</b> — A floppy disk is in the floppy drive. Remove the floppy disk and restart the computer.
<b>Not enough memory or resources. Exit some programs and try again</b> — You have too many programs open. Close all windows and open the program that you want to use.
<b>Operating system not found</b> — Contact Dell. See your <i>Owner's Manual</i> for contact information.
<b>A required .DLL file was not found</b> — The program that you are trying to open is missing an essential file. Remove and then reinstall the program. <ol style="list-style-type: none"><li>1. Click the <b>Start</b> button and then click <b>Control Panel</b>.</li><li>2. Click <b>Add or Remove Programs</b>.</li><li>3. Select the program you want to remove.</li><li>4. Click <b>Remove</b> or <b>Change/Remove</b> and follow the prompts on the screen.</li><li>5. See the program documentation for installation instructions.</li></ol>
<b>x:\ is not accessible. The device is not ready</b> — Insert a disk into the drive and try again.

## Video and Display Problems

### If the display is blank

 **HINT:** If you are using a program that requires a higher resolution than your computer supports, Dell recommends that you attach an external monitor to your computer.

<b>Check the  light</b> — When the  light is blinking, the computer has power. <ol style="list-style-type: none"><li>1. If the  light is blinking, the computer is in standby mode—press the power button to exit standby mode.</li><li>1. If the  light is off, press the power button.</li><li>1. If the  light is on, your power management settings may have caused the display to turn off. Try pressing the power button.</li></ol>
<b>Check the battery</b> — If you are using a battery to power your computer, the battery charge may be depleted. Connect the computer to an electrical outlet using the AC adapter, and turn on the computer.
<b>Test the electrical outlet</b> — Ensure that the electrical outlet is working by testing it with another device, such as a lamp.
<b>Check the AC adapter</b> — Check the AC adapter cable connections. If the AC adapter has a light, ensure that it is on.
<b>Connect the computer directly to an electrical outlet</b> — Bypass power protection devices, power strips, and the extension cable to verify that the computer turns on.
<b>Adjust the Power Properties</b> — Your computer may be in standby or hibernate mode. For information on power management modes, see the <i>Tell Me How</i> help file, or search for the keyword <i>standby</i> or <i>hibernate</i> in the Windows XP Help and Support Center (see " <a href="#">Accessing Help</a> ").
<b>Switch the video image</b> — If your computer is attached to an external monitor, press   to switch the video image to the display.

### If the display is difficult to read

<b>Adjust the brightness</b> — See the <i>Tell Me How</i> help file for instructions on adjusting the brightness (see " <a href="#">Accessing Help</a> ").
<b>Move the subwoofer away from the computer or monitor</b> — If your external speaker system includes a subwoofer, ensure that the subwoofer is at least 60 cm (2 ft) away from the computer or external monitor.

**Eliminate possible interference** — Turn off nearby fans, fluorescent lights, halogen lamps, or other appliances.

**Rotate the computer to face a different direction** — Eliminate sunlight glare, which can cause poor picture quality.

**Adjust the Windows display settings** —

1. Click the **Start** button and then click **Control Panel**.
2. Click **Appearance and Themes**.
3. Click the area you want to change or click the **Display** icon.
4. Try different settings for **Color quality** and **Screen resolution**.

**See "Error Messages"** — If an error message appears, see "[Error Messages](#)."

## If only part of the display is readable

**Connect an external monitor** —

1. Shut down your computer and connect an external monitor to the computer.
2. Turn on the computer and the monitor and adjust the monitor brightness and contrast controls.

If the external monitor works, the computer display or video controller may be defective. Contact Dell. See your *Owner's Manual* for contact information.

## Sound and Speaker Problems

### If you have a problem with integrated speakers

**Adjust the Windows® volume control** — Double-click the speaker icon in the lower-right corner of your screen. Ensure that the volume is turned up and that the sound is not muted. Adjust the volume, bass, or treble controls to eliminate distortion.

**Adjust the volume using keyboard shortcuts** — Press   to disable (mute) or reenable the integrated speakers.

**Reinstall the sound (audio) driver** — See "[Reinstalling Drivers and Utilities](#)."

### If you have a problem with external speakers

 **HINT:** The volume control in some MP3 players overrides the Windows volume setting. If you have been listening to MP3 songs, make sure that you did not turn the player volume down or off.

**Check the speaker cable connections** — See the setup diagram supplied with the speakers.

**Test the electrical outlet** — Ensure that the electrical outlet is working by testing it with another device, such as a lamp.

**Ensure that the speakers are turned on** — See the setup diagram supplied with the speakers.

**Adjust the Windows volume control** — Double-click the speaker icon in the lower-right corner of your screen. Ensure that the volume is turned up and that the sound is not muted. Adjust the volume, bass, or treble controls to eliminate distortion.

**Test the speakers** — Plug the speaker audio cable into the line-out connector on the computer. Ensure that the headphone volume control is turned up. Play a music CD.

**Run the speaker self-test** — Some speaker systems have a self-test button on the subwoofer. See the speaker documentation for self-test instructions.

**Eliminate possible interference** — Turn off nearby fans, fluorescent lights, or halogen lamps to check for interference.

**Reinstall the sound (audio) driver** — See "[Reinstalling Drivers and Utilities](#)."

## Printer Problems

**Check the printer cable connections** — Ensure that the printer cable is properly connected to the computer.

**Test the electrical outlet** — Ensure that the electrical outlet is working by testing it with another device, such as a lamp.

**Ensure that the printer is turned on** — See the documentation supplied with the printer.

**Verify that Windows® recognizes the printer** —

1. Click the **Start** button and then click **Control Panel**.
2. Click **Printers and Other Hardware**.
3. Click **View installed printers or fax printers**. If the printer model is listed, right-click the printer icon.
4. Click **Properties**, and then click the **Ports** tab. Ensure that the **Print to the following port(s)**: setting is **LPT1 (Printer Port)**.

**Reinstall the printer driver** — See "[Reinstalling Drivers and Utilities](#)."

---

## Modem and Internet Connection Problems

➡ **NOTICE:** Connect the modem to an analog telephone wall jack only. Connecting the modem to a digital telephone network damages the modem.

➡ **NOTICE:** Modem and network connectors look similar. Do not plug a telephone line into the network connector.

🔍 **HINT:** If you can connect to your Internet service provider (ISP), your modem is functioning properly. If you are sure that your modem is working properly and you still experience problems, contact your ISP.

**Check the telephone wall jack** — Disconnect the telephone line from the modem and connect it to a telephone. Listen for a dial tone. Ensure that you have touch tone telephone service. Try connecting the modem to a different telephone wall jack.

Slow connection speeds can be caused by telephone noise as well as by telephone line or network conditions. Contact your telephone company or network administrator for more information.

**Connect the modem directly to the telephone wall jack** — If you have other telephone devices sharing the line, such as an answering machine, fax machine, surge protector, or line splitter, then bypass them and use the telephone line to connect the modem directly to the telephone wall jack.

**Check the connection** — Verify that the telephone line is connected to the modem.

**Check the telephone line** — Try using a different telephone line. If you are using a line that is 3 m (10 ft) or more in length, try a shorter one.

**Irregular dial tone** — If you have voice mail service, you might hear an irregular dial tone when you have messages. Contact your telephone company for instructions on restoring a dial tone.

**Turn off call waiting (catch-phone)** — See your telephone directory for instructions on deactivating this feature. Then adjust the dial-up networking connection properties.

1. Click the **Start** button and click **Control Panel**.
2. Click **Printers and Other Hardware**, click **Phone and Modem Options**, click the **Dialing Rules** tab, and then click **Edit...**
3. In the **Edit Location** window, ensure that **To disable call waiting, dial:** is checked, and then select the proper code as listed in your telephone directory.
4. Click **Apply** and click **OK**.
5. Close the **Phone and Modems Options** window.
6. Close the **Control Panel** window.

**Verify that the modem is communicating with Windows** —

1. Click the **Start** button and click **Control Panel**.
2. Click **Printers and Other Hardware** and click **Phone and Modem Options**.
3. Click the **Modems** tab.
4. Click the COM port for your modem.
5. Click **Properties**, click the **Diagnostics** tab, and then click **Query Modem** to verify that the modem is communicating with Windows.

If all commands receive responses, the modem is operating properly.

---

## Scanner Problems

**Check the power cable connection** — Ensure that the scanner power cable is firmly connected to a working electrical outlet and that the scanner is turned on.

**Check the scanner cable connection** — Ensure that the scanner cable is firmly connected to the computer and to the scanner.

**Unlock the scanner** — Ensure that your scanner is unlocked if it has a locking tab or button.

**Reinstall the scanner driver** — See the scanner documentation for instructions.

---

## Touch Pad or Mouse Problems

### Check the touch pad settings —

1. Click the **Start** button, click **Control Panel**, and then click **Printers and Other Hardware**.
2. Click **Mouse**.
3. Try adjusting the settings.

**Check the mouse cable —** Shut down the computer. Disconnect the mouse cable and check it for damage. For PS/2 cables, check the cable connector for bent or broken pins. Firmly reconnect the cable.

If you are using a mouse extension cable, disconnect it and connect the mouse directly to the computer.

### To verify that the problem is with the mouse, check the touch pad —

1. Shut down the computer.
2. Disconnect the mouse.
3. Turn on the computer.
4. At the Windows desktop, use the touch pad to move the cursor around, select an icon, and open it.

If the touch pad operates correctly, the mouse may be defective.

**Reinstall the touch pad driver —** See "[Reinstalling Drivers and Utilities](#)."

## External Keyboard Problems

 **HINT:** When you attach an external keyboard, the integrated keyboard remains fully functional.

**Check the keyboard cable —** Shut down the computer. Disconnect the keyboard cable and check it for damage. For PS/2 cables, check the cable connector for bent or broken pins. Firmly reconnect the cable.

If you are using a keyboard extension cable, disconnect it and connect the keyboard directly to the computer.

### Check the external keyboard —

1. Shut down the computer, wait 1 minute, and turn it on again.
2. Verify that the numbers, capitals, and scroll lock lights on the keyboard blink during the boot routine.
3. From the Windows® desktop, click the **Start** button, point to **Programs**, point to **Accessories**, and click **Notepad**.
4. Type some characters on the external keyboard and verify that they appear on the display.

If you cannot verify these steps, you may have a defective external keyboard.

### To verify that the problem is with the external keyboard, check the integrated keyboard —

1. Shut down the computer.
2. Disconnect the external keyboard.
3. Turn on the computer.
4. From the Windows desktop, click the **Start** button, point to **Programs**, point to **Accessories**, and click **Notepad**.
5. Type some characters on the external keyboard and verify that they appear on the display.

If the characters appear now but did not with the external keyboard, you may have a defective external keyboard. Contact Dell. See your *Owner's Manual* for contact information.

## Unexpected Characters

**Disable the numeric keypad —** Press  to disable the numeric keypad if numbers are displayed instead of letters. Verify that the numbers lock light is not lit.

## Drive Problems

 **HINT:** For information on saving files to a floppy disk, see the *Tell Me How* help file (see "[Accessing Help](#)").

### If you cannot save a file to a floppy disk drive

**Ensure that Windows® recognizes the drive —** Click the **Start** button and click **My Computer**. If the drive is not listed, perform a full scan with your antivirus software to check for and remove viruses. Viruses can sometimes prevent Windows from recognizing the drive. Insert a bootable disk and restart the computer. Verify that the  light is blinking, indicating normal operation.

**Ensure that the disk is not write-protected —** You cannot save data to a write-protected disk.



**Try another floppy disk** — Insert another disk to eliminate the possibility that the original disk is defective.

**Reinstall the drive** —

1. Save and close any open files, exit any open programs, and shut down the computer.
2. Remove the drive from the module bay.
3. Reinstall the drive.
4. Turn on the computer.

**Clean the drive** — See "Cleaning Your Computer" in the *Tell Me How* help file for instructions (see "[Accessing Help](#)").

## If you cannot play a CD, CD-RW, or DVD

 **HINT:** Because of different worldwide file types, not all DVD titles work in all DVD drives.

High-speed CD drive vibration is normal and may cause noise. This noise does not indicate a defect with the drive or the CD.

**Ensure that Windows® recognizes the drive** — Click the **Start** button and click **My Computer**. If the drive is not listed, perform a full scan with your antivirus software to check for and remove viruses. Viruses can sometimes prevent Windows from recognizing the drive. Insert a bootable disk and restart the computer. Verify that the  light is blinking, indicating normal operation.

**Try another disc** — Insert another disc to eliminate the possibility that the original disc is defective.

**Adjust the Windows volume control** — Double-click the speaker icon in the lower-right corner of your screen. Ensure that the volume is turned up and that the sound is not muted.

**Reinstall the drive** —

1. Save and close any open files, exit any open programs, and shut down the computer.
2. Remove the drive.
3. Reinstall the drive.
4. Turn on the computer.

**Clean the drive or disc** — See "Cleaning Your Computer" in the *Tell Me How* help file for instructions (see "[Accessing Help](#)").

## If you cannot eject the CD, CD-RW, or DVD drive tray

1. Ensure that the computer is turned off.
2. Straighten a paper clip and insert one end into the eject hole at the front of the drive; push firmly until the tray is partially ejected.
3. Gently pull out the tray until it stops.

## If you hear an unfamiliar scraping or grinding sound

1. Ensure that the sound is not caused by the program that is running.
1. Ensure that the disk or disc is inserted properly.

## If the CD-RW drive stops writing

**Disable standby or hibernate mode in Windows before writing to a CD-RW** — For more information on disabling power management modes, search for the keyword *standby* or *hibernate* in the Windows XP Help and Support Center (see "[Accessing Help](#)").

**Change the write speed to a slower rate** — See the help files for your CD creation software.

**Exit all other open programs** — Exiting all other open programs before writing to the CD-RW may alleviate the problem.

---

## If you have problems with a hard drive

**Allow the computer to cool before turning it on** — A hot hard drive may prevent the operating system from starting. Try allowing the computer to return to room temperature before turning it on.

### Check the drive for errors —

1. Click the **Start** button and click **My Computer**.
2. Right-click the drive letter (local disk) that you want to scan for errors, and then click **Properties**.
3. Click the **Tools** tab.
4. Under **Error-checking**, click **Check Now**.
5. Click **Start**.

---

## PC Card Problems

**Check the PC Card** — Ensure that the PC Card is properly inserted into the connector. See the *Tell Me How* help file for more information (see "[Accessing Help](#)").

**Ensure that the card is recognized by Windows®** — Double-click the **Unplug or Eject Hardware** icon in the Windows taskbar. Ensure that the card is listed.

**If you have problems with a Dell-provided PC Card** — Contact Dell. See your *Owner's Manual* for contact information.

**If you have problems with a PC Card not provided by Dell** — Contact the PC Card manufacturer.

---

## Network Problems

**Check the network cable connector** — Ensure that the network cable connector is firmly connected to the connector on the computer and the network wall jack.

**Check the network lights on the network connector** — Green indicates that the network connection is active. If the status light is not green, try replacing the network cable. Amber indicates that the network adapter driver is loaded and the adapter is detecting activity.

**Restart the computer** — Try to log on to the network again.

**Contact your network administrator** — Verify that your network settings are correct and that the network is functioning.

---

## General Program Problems



### A program crashes

 **HINT:** Software usually includes installation instructions in its documentation or on a floppy disk or CD.

**See the software documentation** — Many software manufacturers maintain websites with information that may help you solve the problem. Ensure that you properly installed and configured the program. Reinstall the program if necessary.

### A program stops responding

#### End the program —

1. Simultaneously press   .
2. Click the **Applications** tab, and then select the program that is no longer responding.
3. Click **End Task**.

If the computer does not respond to a keystroke or a proper shutdown, press the power button until the computer turns off. Press the power button again to restart the computer.

### Error messages appear

---

Review "[Error Messages](#)" — Look up the message and take the appropriate action. See the software documentation.

---

## E-Mail Problems

Ensure that you are connected to the Internet — With the Outlook Express e-mail program open, click **File**. If **Work Offline** has a check mark next to it, click the check mark to remove it and connect to the Internet.

---

## If Your Computer Gets Wet

 **CAUTION:** Perform this procedure only after you are certain that it is safe to do so. If the computer is connected to an electrical outlet, Dell recommends that you turn off AC power at the circuit breaker before attempting to remove the power cables from the electrical outlet. Use the utmost caution when removing wet cables from a live power source.

1. Shut down the computer, disconnect the AC adapter from the computer, and then disconnect the AC adapter from the electrical outlet.
2. Turn off any attached external devices, and disconnect them from their power sources and then from the computer.
3. Ground yourself by touching one of the metal connectors on the back of the computer.
4. Remove the module bay device and any installed PC Cards, and put them in a safe place to dry.
5. Remove the battery.
6. Wipe off the battery and put it in a safe place to dry.
7. [Remove the hard drive.](#)
8. [Remove the memory module\(s\).](#)
9. Open the display and place the computer right-side up across two books or similar props to let air circulate all around it. Let the computer dry for at least 24 hours in a dry area at room temperature.

 **NOTICE:** Do not use artificial means, such as a hair dryer or a fan, to speed the drying process.

 **CAUTION:** To help prevent electrical shock, verify that the computer is thoroughly dry before continuing with the rest of this procedure.

10. Ground yourself by touching one of the metal connectors on the back of the computer.
11. [Replace the memory module\(s\), the memory module cover, and the screw\(s\).](#)
12. [Replace the hard drive.](#)
13. Replace the module bay device and any PC Cards you removed.
14. Replace the battery.
15. Turn on the computer and verify that it is working properly.

 **HINT:** See "Limited Warranties and Return Policy" in your *Owner's Manual* for information on your warranty coverage.

If the computer does not start, or if you cannot identify the damaged components, contact Dell. See your *Owner's Manual* for contact instructions.

---

## If You Drop or Damage Your Computer

1. Save and close any open files, exit any open programs, and shut down the computer.
2. Disconnect the AC adapter from the computer and from the electrical outlet.
3. Turn off any attached external devices, and disconnect them from their power sources and then from the computer.
4. Remove and reinstall the battery.
5. Turn on the computer.

 **HINT:** See "Limited Warranties and Return Policy" in your *Owner's Manual* for information on your warranty coverage.

If the computer does not start, or if you cannot identify the damaged components, contact Dell. See your *Owner's Manual* for contact instructions.

---

## Resolving Other Technical Problems

Go to the Dell | Support website — Go to [support.dell.com](http://support.dell.com) for help with general usage, installation, and troubleshooting questions. See "Dell Technical Support Policy (U.S. Only)" in your *Owner's Manual* for a description of the hardware and software support provided by Dell.



**E-mail Dell** — Go to [support.dell.com](http://support.dell.com) and then click **E-Mail Dell** in the **Communicate** list. Send an e-mail message to Dell about your problem; you can expect to receive an e-mail message from Dell within hours. See "Dell Technical Support Policy (U.S. Only)" in your *Owner's Manual* for a description of the hardware and software support provided by Dell.

**Contact Dell** — If you cannot solve your problem using the Dell support website or e-mail service, call Dell for technical assistance. See your *Owner's Manual* for contact information. See "Dell Technical Support Policy (U.S. Only)" in your *Owner's Manual* for a description of the hardware and software support provided by Dell.

---

[Back to Contents Page](#)

## Speakers

Dell™ Inspiron™ 4150

### Removing the Speaker Assemblies

- ➔ **NOTICE:** Disconnect the computer and any attached devices from electrical outlets, and remove any installed batteries.
- ➔ **NOTICE:** To avoid ESD, ground yourself by using a wrist grounding strap or by touching an unpainted metal surface on the computer.
- ➔ **NOTICE:** Read "[Preparing to Work Inside the Computer](#)" before performing the following procedure.

The speakers are located on the front-left and front-right sides of the bottom case. Take note of the speaker and antenna wire routing so that you can replace them properly under their routing clips.

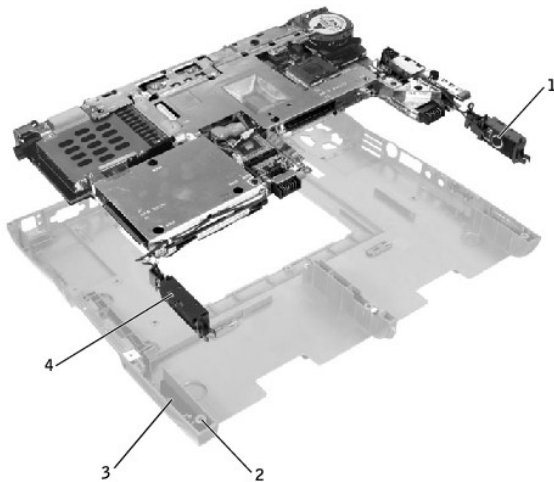
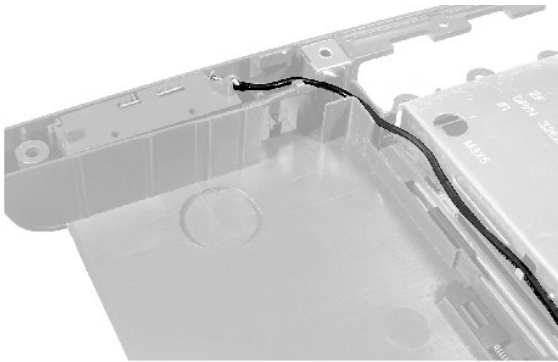

1	right speaker
2	palm-rest screw post
3	bottom case holders (2)
4	left speaker

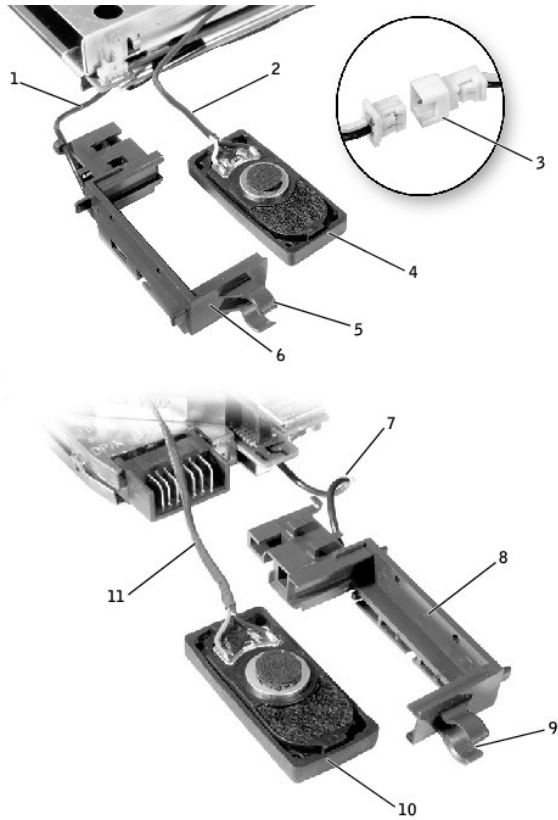

1	antenna cable	7	antenna cable
2	speaker interface cable	8	right speaker holder
3	in-line connector	9	mounting ring
4	left speaker	10	right speaker
5	mounting ring	11	speaker interface cable
6	left speaker holder		

1. Remove the [hard drive](#).
2. Remove the [keyboard](#).
3. Remove the [display](#).
4. Remove the [palm rest](#).
5. Disconnect the speaker interface cable connectors. (Do not attempt to disconnect the antenna cables.)

➡ **NOTICE:** Do not pull the antenna wire when removing the speaker.

➡ **NOTICE:** Handle the speaker assemblies and speakers with care to avoid damaging the speaker cones.

6. Remove the speaker assemblies by pulling them straight up and out of the bottom case.
7. Remove the speakers from the holders by sliding the speakers out the bottom of the holders.

🔍 **HINT:** The left speaker has an in-line connector, and its antenna cable is longer than the antenna cable of the right speaker.

## Replacing the Speaker Assemblies

1. Slide the new speaker into its holder so that the speaker faces outward (toward the speaker grill on the side of the computer) when the speaker assembly is installed.
2. Place the mounting ring over the front palm-rest screw post.

➡ **NOTICE:** Ensure that the speaker wires are routed securely under their mounting clips.

3. Slide the speaker assembly down into the bottom case.

---

[Back to Contents Page](#)

[Back to Contents Page](#)

## Specifications

Dell™ Inspiron™ 4150

- [Microprocessor](#)
- [System Information](#)
- [PC Card](#)
- [Memory](#)
- [Ports and Connectors](#)
- [Communications](#)
- [Video](#)
- [Audio](#)
- [Display](#)
- [Keyboard](#)
- [Touch Pad](#)
- [Track Stick](#)
- [Battery](#)
- [AC Adapter](#)
- [Physical](#)
- [Environmental](#)

Microprocessor	
Microprocessor type	Intel® Mobile Pentium® 4M microprocessor that runs at 1.6, 1.7, 1.9, or 2.0 GHz
L1 cache	8KB (internal)
L2 cache	512 KB (on die)
External bus frequency	400 MHz

System Information	
System chip set	Intel 845MP
Data bus width	64 bits
DRAM bus width	64 bits
Microprocessor address bus width	32 bits

PC Card	
CardBus controller	Texas Instruments PCI 1420 CardBus controller
PC Card connector	two (supports two Type I or Type II cards or one Type III card)
Cards supported	3.3 V and 5 V
PC Card connector size	68 pins
Data width (maximum)	PCMCIA 16 bits CardBus 32 bits

Memory	
Memory module connector	two user-accessible SODIMM sockets
Memory module capacities	128, 256, and 512 MB
Memory type	266-MHz DDR SDRAM
Standard memory	128 MB
Maximum memory	1 GB

Ports and Connectors	
Serial	9-pin connector; 16550C-compatible, 16-byte buffer connector
Parallel	25-hole connector; unidirectional, bidirectional, or ECP
Video	15-hole connector
Audio	microphone connector, stereo headphone/speakers connector
PS/2 keyboard/mouse	6-pin mini-DIN connector
USB	4-pin USB-compliant connector
Infrared	sensor compatible with IrDA Standard 1.1 (Fast IR) and IrDA Standard 1.0 (Slow IR)
Docking	200-pin connector for a Dell™ docking device
S-video TV-out	7-pin mini-DIN connector (optional S-video to composite video adapter cable)
Mini PCI	Type IIIA Mini PCI card slot with Wi-Fi (802.11b) wireless support
Modem	RJ-11 port
Network adapter	RJ-45 port

Communications	
----------------	--

Modem:	
Type	v.92 56K MDC
Controller	softmodem
Interface	internal AC 97 bus
Network adapter	10/100 Ethernet LOM

<b>Video</b>	
Video type	64-bit hardware accelerated
Data bus	4X AGP
Video controller	ATI Mobility RADEON 7500C
Video memory	16 MB or 32 MB
LCD interface	LVDS
TV support	NTSC or PAL in S-video and composite modes

<b>Audio</b>	
Audio type	AC97 (Soft Audio)
Audio controller	Cirrus Logic CS4205
Stereo conversion	18-bit (analog-to-digital and digital-to-analog)
Interfaces:	
Internal	PCI bus/AC 97
External	microphone-in connector, stereo headphones/speakers connector
Speaker	two 4-ohm speakers
Internal speaker amplifier	1.0-W channel into 4 ohms
Volume controls	keyboard shortcuts, program menus

<b>Display</b>	
Type (active-matrix TFT)	XGA; SXGA+; UXGA
Dimensions:	
Height	214.3 mm (8.4 inches)
Width	285.7 mm (11.3 inches)
Diagonal	357.1 mm (14.1 inches)
Maximum resolutions	1024 x 768 at 16.8 million colors (XGA) 1400 x 1050 at 16.8 million colors (SXGA+) 1600 x 1200 at 16.8 million colors (UXGA)
Response time (typical)	20-ms rise (maximum), 30-ms fall (maximum)
Refresh rate	60 Hz
Operating angle	0° (closed) to 180°
Viewing angles:	
Horizontal	±40°
Vertical	+10°/-30°
Pixel pitch	0.28 x 0.28 mm (XGA) 0.20 x 0.20 mm (SXGA+) 0.18 x 0.18 mm (UXGA)
Power Consumption:	
Panel with backlight (typical)	6.5 W (XGA) 7.0 W (SXGA+) 7.5 W (UXGA)
Controls	brightness can be controlled through keyboard shortcuts

<b>Keyboard</b>	
Number of keys	87 (U.S. and Canada); 88 (Europe); 91 (Japan)
Key travel	2.7 mm ± 0.3 (0.11 inch ± 0.016 inch)
Key spacing	19.05 mm ± 0.3 mm (0.75 inch ± 0.012 inch)
Layout	QWERTY/AZERTY/Kanji

<b>Touch Pad</b>	
X/Y position resolution (graphics table mode)	240 cpi
Size:	
Width	64.8-mm (2.55-inch) sensor-active area
Height	48.88-mm (1.92-inch) rectangle

<b>Track Stick</b>	
X/Y position resolution (graphics table mode)	250 count/sec @ 100 gf
Size	protrudes 0.5 mm higher than surrounding keycaps

<b>Battery</b>	
Type	8-cell "smart" lithium ion (4460 mAh)
Dimensions:	
Depth	88.5 mm (3.48 inches)
Height	21.5 mm (0.83 inch)
Width	139.0 mm (5.47 inches)
Weight	0.43 kg (0.95 lb)
Voltage	14.8 VDC
Charge time (approximate):	
Computer on	2.5 hours
Computer off	1 hour
Operating time	3 to 4 hours with average usage; can be significantly reduced under certain power-intensive conditions  See the <i>Tell Me How</i> help file for more information on battery life. See " <a href="#">Accessing Help</a> ."
Life span (approximate)	400 discharge/charge cycles
Temperature range:	
Operating	0° to 35°C (32° to 95°F)
Storage	-40° to 65°C (-40° to 149°F)

<b>AC Adapter</b>	
Input voltage	90-264 VAC
Input current (maximum)	1.5 A
Input frequency	47-63 Hz
Output current	3.5 A
Output power	70 W
Rated output voltage	20 VDC
Dimensions:	
Height	27.94 mm (1.1 inches)
Width	58.42 mm (2.3 inches)
Depth	130.80 mm (5.15 inches)
Weight (with cables)	0.4 kg (0.9 lb)
Temperature range:	
Operating	0° to 35°C (32° to 95°F)
Storage	-40° to 65°C (-40° to 149°F)

<b>Physical</b>	
Height	36.8 mm (1.4 inches)
Width	319.5 mm (12.5 inches)
Depth	253.6 mm (9.9 inches)
Weight (with 8-cell battery):	
With travel module	2.4 kg (5.3 lb)
With floppy disk drive	2.6 kg (5.7 lb)
With CD drive	2.6 kg (5.8 lb)

<b>Environmental</b>	
Temperature range:	
Operating	0° to 35°C (32° to 95°F)
Storage	-40° to 65°C (-40° to 149°F)
Relative humidity (maximum):	
Operating	10% to 90% (noncondensing)
Storage	5% to 95% (noncondensing)
Maximum vibration (using a random-vibration spectrum that simulates user environment):	
Operating	0.9 GRMS

Storage	1.3 GRMS
Maximum shock (measured with the hard drive in head-parked position and a 2-ms half-sine pulse):	
Operating	122 G
Storage	163 G
Altitude (maximum):	
Operating	-15.2 to 3048 m (-50 to 10,000 ft)
Storage	-15.2 to 10,668 m (-50 to 35,000 ft)

---

[Back to Contents Page](#)



## System Board

Dell™ Inspiron™ 4150

### Removing the System Board

The system board's BIOS chip contains the service tag sequence, which is also visible on a barcode label on the bottom of the computer. The replacement kit for the system board includes a CD that provides a utility for transferring the service tag sequence to the replacement system board.

- ➔ **NOTICE:** Disconnect the computer and any attached devices from electrical outlets, and remove any installed batteries.
- ➔ **NOTICE:** To avoid ESD, ground yourself by using a wrist grounding strap or by touching an unpainted metal surface on the computer.
- ➔ **NOTICE:** Read "[Preparing to Work Inside the Computer](#)" before performing the following procedure.

1. Remove the [hard drive](#).
2. Remove the [keyboard](#).
3. Remove the [display](#).
4. Remove the [palm rest](#).
5. Remove the [microprocessor thermal cooling assembly](#).
6. Remove the [microprocessor](#).
7. Remove the [modem, memory modules](#), and [Mini PCI card](#).
8. From the bottom of the computer, remove the six M2.5 x 5-mm screws labeled "circle B" that secure the system board to the bottom case.
9. Remove the three M2.5 x 5-mm screws labeled "circle B" that secure the fan guard to the bottom case.

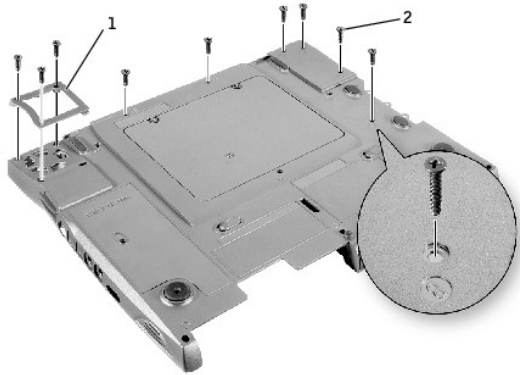

1	fan guard
2	M2.5 x 5-mm screws (9)

10. Turn the computer over and remove the M2.5 x 5-mm screw, which is labeled "circle B" with an arrow, by the battery connector on the front center of the system board.

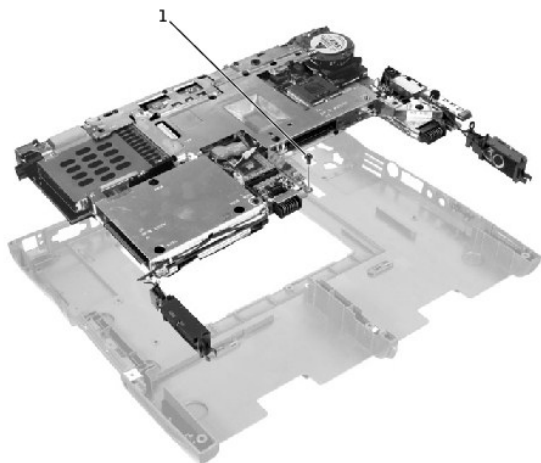

1	M2.5 x. 5-mm screw (1)
---	------------------------

11. Remove the [speaker assemblies](#) from the bottom case.
12. Pull the right side of the bottom case, next to the external headphone and microphone connectors, away from the system board as you simultaneously lift the front of the system board out and away from the bottom case.

## Replacing the System Board

1. Install the [microprocessor](#) on the replacement system board.
2. Install the replacement system board:
  - a. Insert the external microphone and headphone connectors through the bottom case.
  - b. Replace the six M2.5 x 5-mm screws, starting on the right side of the bottom case.
  - c. Replace the fan guard, inserting the tab into the bottom case, and replace the three M2.5 x 5-mm screws. Replacing the screw opposite the tab first makes it easier to insert and replace the other two screws.
3. Install the modem and the microprocessor thermal cooling assembly that you removed from the old system board.

 **HINT:** Route cables so that they are not crimped or pinched when the complete assembly is put back together.

4. Connect the right and left [speaker assemblies](#) that came with the new system board in the bottom case.
5. Replace the palm rest, the keyboard, the display, and the hard drive.
6. Replace the module bay devices and any PC Cards or plastic blanks in the PC Card slot.
7. Insert the CD that accompanied the replacement system board into the drive, and turn on the computer. Follow the instructions on the screen.

 **HINT:** After installing the system board, enter the computer service tag sequence into the BIOS of the replacement system board.

---

[Back to Contents Page](#)

## System Components

Dell™ Inspiron™ 4150

- ⚠ **NOTICE:** Only a certified service technician should perform repairs on your computer. Damage due to servicing that is not authorized by Dell is not covered by your warranty.
- ⚠ **NOTICE:** Unless otherwise noted, each procedure in this manual assumes that a part can be installed by performing the removal procedure in reverse order.

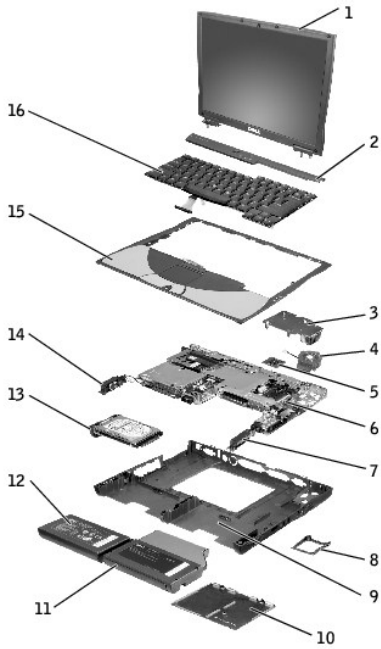

1	top cover display assembly	9	bottom case assembly
2	center control cover	10	memory module cover
3	thermal cooling assembly	11	module bay device
4	hybrid cooling fan	12	main battery
5	microprocessor module	13	hard drive
6	system board	14	left speaker/antenna assembly
7	right speaker/antenna assembly	15	palm rest assembly
8	fan guard	16	keyboard

## Microprocessor Thermal Cooling Assembly

Dell™ Inspiron™ 4150

---

### Removing the Microprocessor Thermal Cooling Assembly

- ➔ **NOTICE:** Disconnect the computer and any attached devices from electrical outlets, and remove any installed batteries.
- ➔ **NOTICE:** To avoid ESD, ground yourself by using a wrist grounding strap or by touching an unpainted metal surface on the computer.
- ➔ **NOTICE:** Read "[Preparing to Work Inside the Computer](#)" before performing the following procedure.

1. Remove the [hard drive](#).
2. Remove the [keyboard](#).
3. Loosen the four captive screws that secure the microprocessor thermal cooling assembly to the system board.

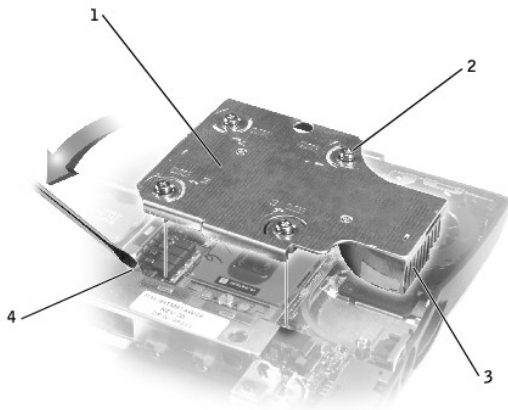

1	microprocessor thermal cooling assembly
2	captive screws (4)
3	right side of the thermal cooling assembly
4	recess in the EMI shield (prying location)

4. Insert a screwdriver into the recess in the EMI shield under the front-left corner of the thermal cooling assembly, and pry the assembly up and away from the system board.

### Replacing the Microprocessor Thermal Cooling Assembly

- ➔ **NOTICE:** When replacing the microprocessor, to ensure proper thermal operation, always install a new thermal cooling assembly that is compatible with the new microprocessor.

1. Place the right side of the microprocessor thermal cooling assembly under the palm rest, and lower the assembly onto the system board.
  2. Tighten the four captive screws, labeled "1" through "4," in consecutive order.
-

[Back to Contents Page](#)

## A Tour of Your Computer

Dell™ Inspiron™ 4150

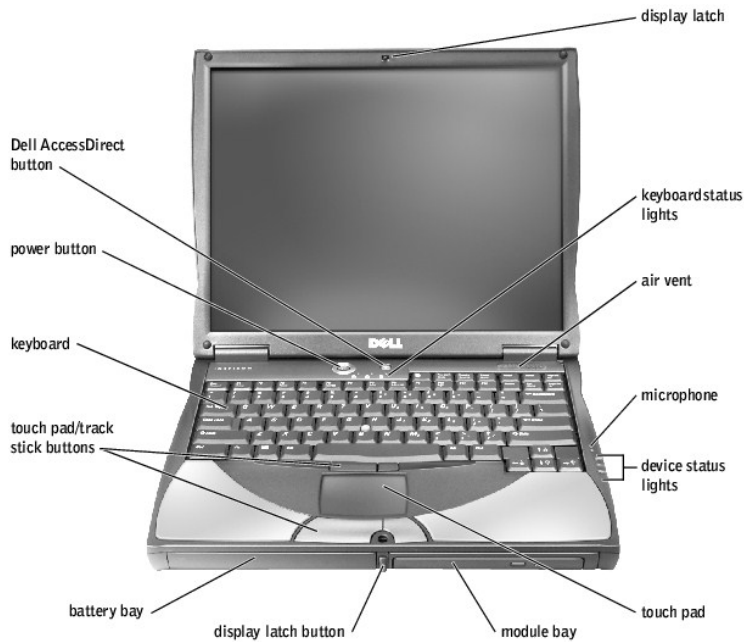

- [Front View](#)
- [Left Side View](#)
- [Right Side View](#)
- [Back View](#)
- [Bottom View](#)

### Front View



**Display Latch** — Keeps the display closed.

**Keyboard Status Lights** — The green lights located above the keyboard indicate the following:

	Turns on when the numeric keypad is enabled
	Turns on when the caps lock function is enabled
	Turns on when the scroll lock function is enabled

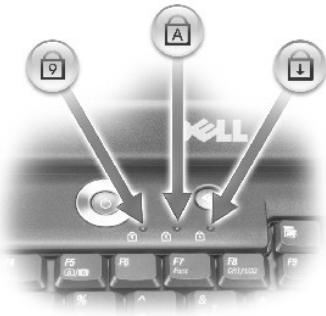





**Air Vent** — The computer uses an internal fan to create airflow through the vents, which prevents the computer from overheating.

 **HINT:** The computer turns on the fans when the computer gets hot. The fans may make noise, which is normal and does not indicate a problem with the fans or the computer.

 **CAUTION:** Do not block, push objects into, or allow dust to accumulate in the air vents. Do not store your computer in a low-airflow environment, such as a closed briefcase, while it is running. Restricting the airflow can damage the computer or cause a fire.

**Microphone** — Allows you to record audio.

#### Device Status Lights

	Turns on when you turn on the computer.
	Turns on when the computer reads or writes data.   <b>NOTICE:</b> To avoid loss of data, never turn off the computer while the  light is flashing.
	Turns on steadily or blinks when the computer is in a power management mode. It also blinks to indicate battery charge status.

If the computer is connected to an electrical outlet, the  light operates as follows:

- o Solid green: The battery is charging.
- o Flashing green: The battery is fully charged.

If the computer is running on a battery, the  light operates as follows:

- o Off: The battery is adequately charged (or the computer is turned off).
- o Flashing orange: The battery charge is low.
- o Solid orange: The battery charge is critically low.

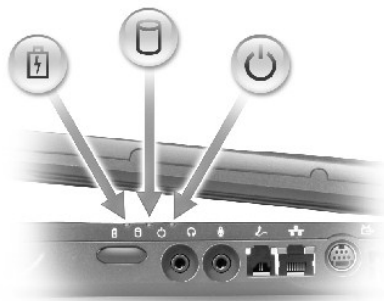

**Touch Pad** — Use the touch pad and touch pad buttons as you would use a mouse. For more information, see the *Tell Me How* help file (see "[Accessing Help](#)").

**Module Bay** — You can install devices such as an optical drive or the Dell TravelLite™ module in the module bay.

**Display Latch Button** — Press this button to release the display latch and open the display.

**Battery Bay** — When a battery is installed, you can use the computer without connecting it to an electrical outlet. For more information, see the *Tell Me How* help file (see "[Accessing Help](#)").

**Touch Pad/Track Stick Buttons** — Correspond to the left and right buttons on a standard mouse.

**Keyboard** — The keyboard includes a numeric keypad as well as the Microsoft® Windows® logo key, . For information on supported keyboard shortcuts, see the *Tell Me How* help file (see "[Accessing Help](#)").

**Power Button** — Press the power button to turn on the computer or to enter or exit a power management mode.

If the computer stops responding, press and hold the power button until the computer turns off completely (which may take about 4 seconds).

 **NOTICE:** Turn off your computer by performing a Windows shutdown. Otherwise, you may lose data.

**Dell™ AccessDirect™ Button** — Press this button to launch various resources, such as support and educational tools. For more information, see the *Tell Me How* help file (see "[Accessing Help](#)").

---

## Left Side View

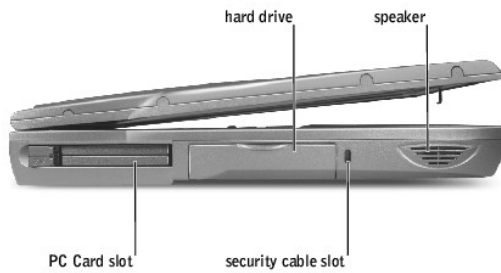

**PC Card Slot** — Has two connectors that support various types of PC Cards, including modems and network adapters. For more information, see the *Tell Me How* help file (see "[Accessing Help](#)").

**Hard Drive** — Stores software and data.

**Security Cable Slot** — Lets you attach a commercially available antitheft device to the computer. Instructions for installing antitheft devices are usually included with the device.

➔ **NOTICE:** Before you buy an antitheft device, ensure that it will work with the security cable slot.

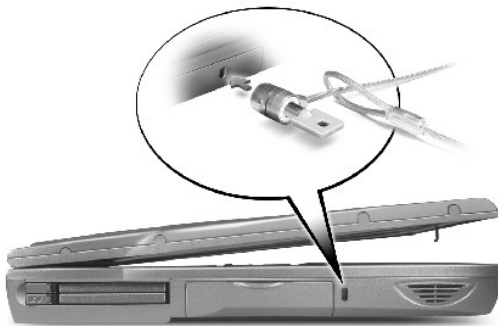

**Speakers** — Press the volume control keyboard shortcuts to adjust the volume of the integrated speakers. For more information, see the *Tell Me How* help file (see "[Accessing Help](#)").

## Right Side View

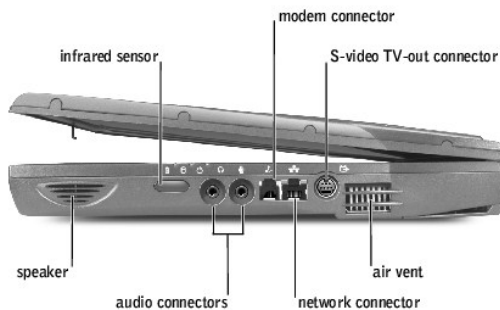

**Speakers** — Press the volume control keyboard shortcuts to adjust the volume of the integrated speakers. For more information, see the *Tell Me How* help file (see "[Accessing Help](#)").

**Infrared Sensor** — The infrared sensor lets you transfer files from your computer to another infrared-compatible device without using cable connections.

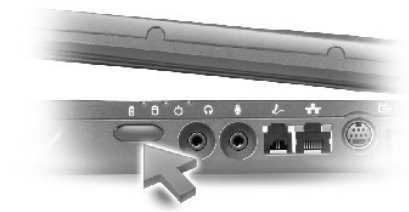

#### Audio Connectors

Attach a microphone to the  connector.

Attach headphones or speakers to the  connector.

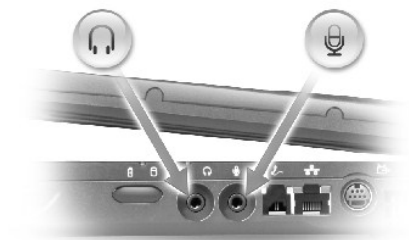

#### Modem Connector

	<p>Connect the telephone line to the optional modem connector.</p> <p>For information on using the modem, see the online modem documentation supplied with your computer. To access device user's guides, see "Need Additional Help?" in the <i>Tell Me How</i> help file (see "<a href="#">Accessing Help</a>").</p>
---	---

#### Network Connector

	<p>Connects the computer to a network. The lights next to the connector indicate activity for both wired and wireless network communications.</p> <p>For information on using the network adapter, see the online network adapter documentation supplied with your computer. To access device user's guides, see "Need Additional Help?" in the <i>Tell Me How</i> help file (see "<a href="#">Accessing Help</a>").</p>
---	--

 **NOTICE:** The network connector is slightly larger than the modem connector. Do not plug a telephone line into the network connector.

#### S-Video TV-Out Connector

	<p>Connects your computer to a TV.</p>
---	--

**Air Vent** — The computer uses an internal fan to create airflow through the vents, which prevents the computer from overheating.

 **HINT:** The computer turns on the fans when the computer gets hot. The fans may make noise, which is normal and does not indicate a problem with the fans or the computer.



**CAUTION:** Do not block, push objects into, or allow dust to accumulate in the air vents. Do not store your computer in a low-airflow environment, such as a closed briefcase, while it is running. Restricting the airflow can damage the computer or cause a fire.

## Back View

**NOTICE:** To avoid damaging the computer, wait 5 seconds after turning off the computer before you disconnect an external device.

**CAUTION:** Do not block, push objects into, or allow dust to accumulate in the air vents. Do not store your computer in a low-airflow environment, such as a closed briefcase, while it is running. Restricting the airflow can damage the computer or cause a fire.

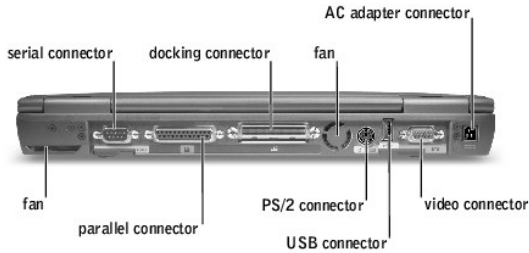

**Fan** — The computer uses an internal fan to create airflow through the vents, which prevents the computer from overheating.

### Serial Connector

	<p>Connects serial devices, such as a mouse or handheld device.</p>
--	---

### Parallel Connector

	<p>Connects a parallel device, such as a printer. You can also connect the optional floppy drive directly to the parallel connector using the optional floppy drive cable.</p>
--	--

### Docking Connector

**HINT:** Docking devices may not be available in some countries.

	<p>Connects the optional docking device. A docking device allows you to easily use external devices with your computer, such as an external keyboard, mouse, and monitor.</p> <p>See the documentation that came with your docking device for additional information.</p>
--	---

### PS/2 Connector

**HINT:** You can use the integrated keyboard and an external keyboard at the same time. When you attach a PS/2 keyboard or PS/2 numeric keypad, the integrated keypad is disabled.

	<p>Connects PS/2-compatible devices, such as a mouse, keyboard, or external numeric keypad.</p> <p>Shut down the computer before attaching or removing a PS/2-compatible device. If the device does not work, install the device drivers from the floppy disk or CD that came with the device, and restart the computer.</p>
--	--

### USB Connector

	<p>Connects USB devices, such as a mouse, keyboard, or printer.</p>
--	---



### Video Connector

	<p>Connects an external monitor. For more information, see "Using the Display" in the <i>Tell Me How</i> help file (see "<a href="#">Accessing Help</a>").</p>
--	--

**AC Adapter Connector** — Attach the AC adapter to the computer.



The AC adapter converts AC power to the DC power required by the computer. You can connect the AC adapter with your computer turned either on or off.

-  **CAUTION:** The AC adapter works with electrical outlets worldwide. However, power connectors and power strips vary among countries. Using an incompatible cable or improperly connecting the cable to the power strip or electrical outlet may cause fire or equipment damage.
  -  **NOTICE:** When you disconnect the AC adapter from the computer, grasp the adapter cable connector, not the cable itself, and pull firmly but gently to avoid damaging the cable.
- 

## Bottom View

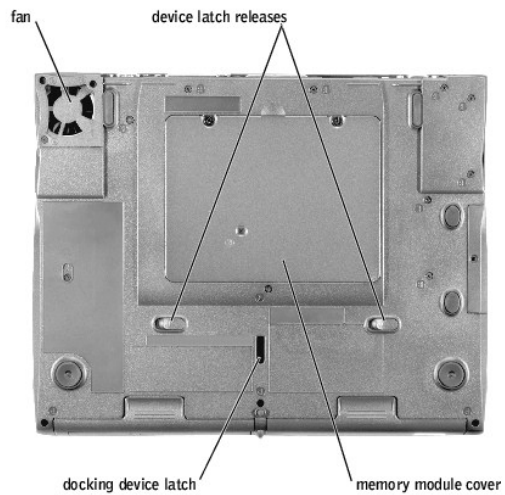

**Fan** — The computer uses an internal fan to create airflow through the vents, which prevents the computer from overheating.

**Device Latch Releases** — Press a latch release to remove a device in the module or battery bay.

**Memory Module Cover** — Protects the memory module(s), the optional Mini PCI card, and the optional modem (see "[Memory Modules, Mini PCI Card, and Modem](#)").

**Docking Device Latch** — Latches onto the docking device.

---

[Back to Contents Page](#)

## Memory Modules, Mini PCI Card, and Modem

Dell™ Inspiron™ 4150

- [Memory Modules](#)
  - [Mini PCI Card](#)
  - [Modem](#)
- 

### Memory Modules

#### Removing the Memory Module Cover

- ➔ **NOTICE:** Disconnect the computer and any attached devices from electrical outlets, and remove any installed batteries.
- ➔ **NOTICE:** To avoid ESD, ground yourself by using a wrist grounding strap or by touching an unpainted metal surface on the computer.
- ➔ **NOTICE:** Read "[Preparing to Work Inside the Computer](#)" before performing the following procedure.

1. Turn the computer over and release the two captive screws from the cover.
2. Remove the M2.5 x 12-mm screw labeled "circle K" from the cover. (This screw is also one of the five keyboard screws.)
3. Place your finger under the cover at the indentation and lift and slide the cover open.

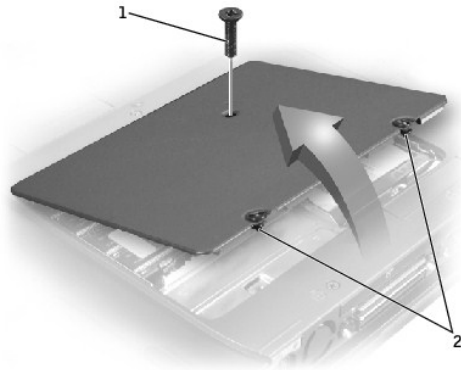

1	M2.5 x 12-mm screw (1)
2	captive screws (2)

#### Removing the Memory Modules

- ➔ **NOTICE:** Disconnect the computer and any attached devices from electrical outlets, and remove any installed batteries.
- ➔ **NOTICE:** To avoid ESD, ground yourself by using a wrist grounding strap or by touching an unpainted metal surface on the computer.
- ➔ **NOTICE:** Read "[Preparing to Work Inside the Computer](#)" before performing the following procedure.

1. Remove the [memory module cover](#).

- ➔ **NOTICE:** To prevent damage to the memory module connector, do not use tools to spread the inner metal tabs that secure the memory module.

2. Use your fingertips to carefully spread apart the inner tabs on each end of the memory module connector.

The module pops up.

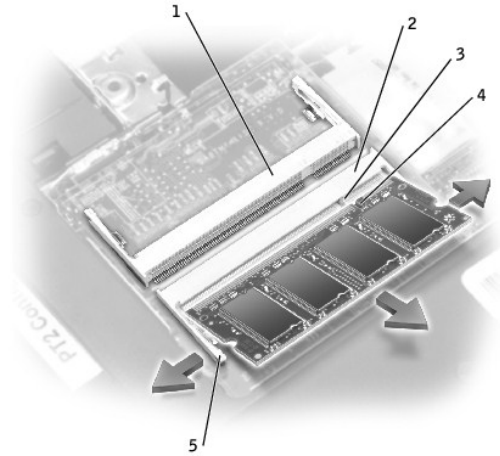



1	JDIM 1 connector
2	JDIM 2 connector
3	keying tab
4	keying notch on memory module
5	inner tabs (2 per connector)

3. Lift the memory module out of its connector.

## Replacing Memory Modules

1. If you only have one memory module, install it in the connector labeled "JDIM1" on the system board. Install a second memory module in the connector labeled "JDIM2."

 **HINT:** Memory modules are keyed, or designed to fit into their connectors, in only one direction.

 **NOTICE:** The memory module must be inserted at a 45-degree angle to avoid damaging the connector.

2. Align the notch in the memory module edge connector with the keying tab in the connector on the system board.
3. Slide the edge connector of the module firmly into the connector at a 45-degree angle, and rotate the module down until you hear a click. If you do not hear the click, remove the module and reinstall it.
4. Replace the cover and tighten the two captive screws.

## Mini PCI Card

You must remove the Mini PCI card before the system board can be removed.

### Removing the Mini PCI Card

 **NOTICE:** Disconnect the computer and any attached devices from electrical outlets, and remove any installed batteries.

 **NOTICE:** To avoid ESD, ground yourself by using a wrist grounding strap or by touching an unpainted metal surface on the computer.

 **NOTICE:** Read "[Preparing to Work Inside the Computer](#)" before performing the following procedure.

1. Remove the [memory module cover](#).
2. Disconnect the Mini PCI card from any attached cables.
3. Release the Mini PCI card by spreading the metal securing tabs until the card pops up slightly.
4. Lift the Mini PCI card out of its connector.

 **NOTICE:** To avoid damaging the Mini PCI card, never place cables on top of or under the card.

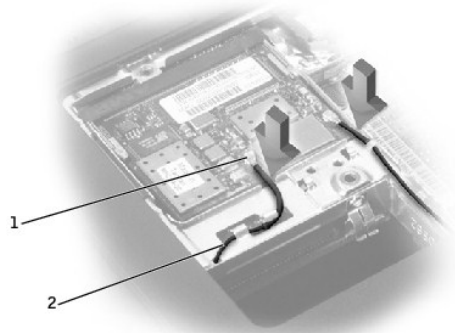

1	antenna connectors on card (2)
2	antenna cables (2)

## Replacing the Mini PCI Card

1. Align the Mini PCI card with the connector at a 45-degree angle, and press the Mini PCI card into the connector until you hear a click.

➔ **NOTICE:** The connectors are keyed to ensure correct insertion. If you feel resistance, check the connectors and realign the card.

2. Connect the antenna cables to the Mini PCI card.
3. Replace the cover, and tighten the screws.

## Modem

### Removing the Modem

➔ **NOTICE:** Disconnect the computer and any attached devices from electrical outlets, and remove any installed batteries.

➔ **NOTICE:** To avoid ESD, ground yourself by using a wrist grounding strap or by touching an unpainted metal surface on the computer.

➔ **NOTICE:** Read "[Preparing to Work Inside the Computer](#)" before performing the following procedure.

1. Remove the [memory module cover](#).
2. Remove the two M2 x 3-mm screws that secure the modem to the system board.

➔ **NOTICE:** Do not pull on the modem cable. Pull from the modem connector to disconnect the cable.

3. Pull straight up on the attached pull-tab to lift the modem out of its connector on the system board and disconnect the modem cable.

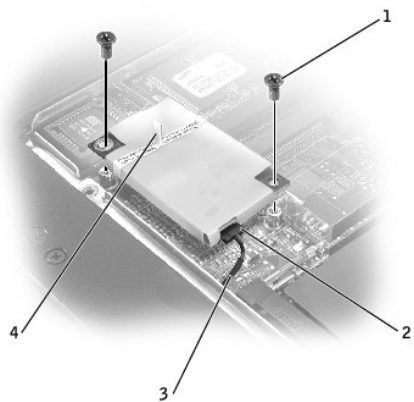

1	M2 x 3-mm screws (2)
2	modem connector
3	modem cable
4	pull-tab

## Replacing the Modem

1. Connect the modem cable to the modem.

➡ **NOTICE:** The connectors are keyed for correct insertion; do not force the connections.

2. Align the modem with the screw holes on the system board and *press down on the pull-tab* to seat the modem in the connector.

➡ **NOTICE:** Pressing down on the modem anywhere other than on the pull-tab can break the modem.

3. Install the two M2 x 3-mm screws that secure the modem to the system board.
4. Replace the cover, and tighten the screws.

---

[Back to Contents Page](#)



## Reinstalling the Microsoft® Windows® XP Operating System



Dell™ Inspiron™ 4150

---

Before reinstalling the Microsoft Windows XP operating system to correct a problem, try correcting the problem by using [Windows System Restore](#).

**NOTICE:** The *Operating System* CD provides options for reinstalling the Windows XP operating system. The options can potentially overwrite files installed by Dell and possibly affect programs installed on your hard drive. Therefore, do not reinstall your operating system unless instructed to do so by a Dell technical support representative.

1. Insert the *Operating System* CD.
2. Shut down the computer, and then turn on the computer.
3. Press any key when the **Press any key to boot from CD** message appears on the screen.
4. When the **Windows XP Setup** screen appears, press  to select **To set up Windows now**.
5. Read the information in the **License Agreement** window, and then press  on your keyboard to agree with the license information.
6. If your computer already has Windows XP installed and you want to recover your current Windows XP data, type **r** to select the repair option, and then go to [step 15](#).

If you want to install a new copy of Windows XP, press  to select the fresh copy option and then press  on the next screen to select the highlighted partition (recommended). Then follow the instructions on the screen.

7. The **Windows XP Setup** screen appears and Windows XP begins to copy files and install the device drivers. The computer automatically restarts multiple times before it requires additional input.
8. When the **Welcome to Microsoft** screen appears, click the green arrow icon at the bottom of the screen to continue. Then follow the instructions on the screen to finish the installation.
9. When the **Regional Settings** screen appears, select the settings for your locale, and then click **Next**.
10. Enter your name and organization in the **Personalize Your Software** screen, and then click **Next**.
11. *If you are reinstalling Windows XP Home Edition*, enter a name for your computer when the **Computer Name** window appears, and then click **Next**.  
*If you are reinstalling Windows XP Professional*, enter a name for your computer and a password when the **Computer Name and Administrator Password** window appears, and then click **Next**.
12. If you have a modem installed, the **Modem Dialing Information** screen appears. Enter the requested information and click **Next**.
13. Enter the date, time, and time zone in the **Date and Time Settings** window and click **Next**.
14. If your computer has a network adapter, select the appropriate network settings. If your computer does not have a network adapter, you do not see this option.

Windows XP begins to install its components and configure the computer. The computer automatically restarts.

15. When the **Welcome to Microsoft** screen appears, click the green arrow icon at the bottom of the screen to continue. Then follow the instructions on the screen to complete the installation.
  16. Remove the CD from the drive.
  17. [Reinstall the appropriate drivers](#).
  18. Reinstall your virus protection software.
-